

ELECTRICAL

TROUBLESHOOTING

1988
COMANCHE

USA/Canada Edition 8980 010 611

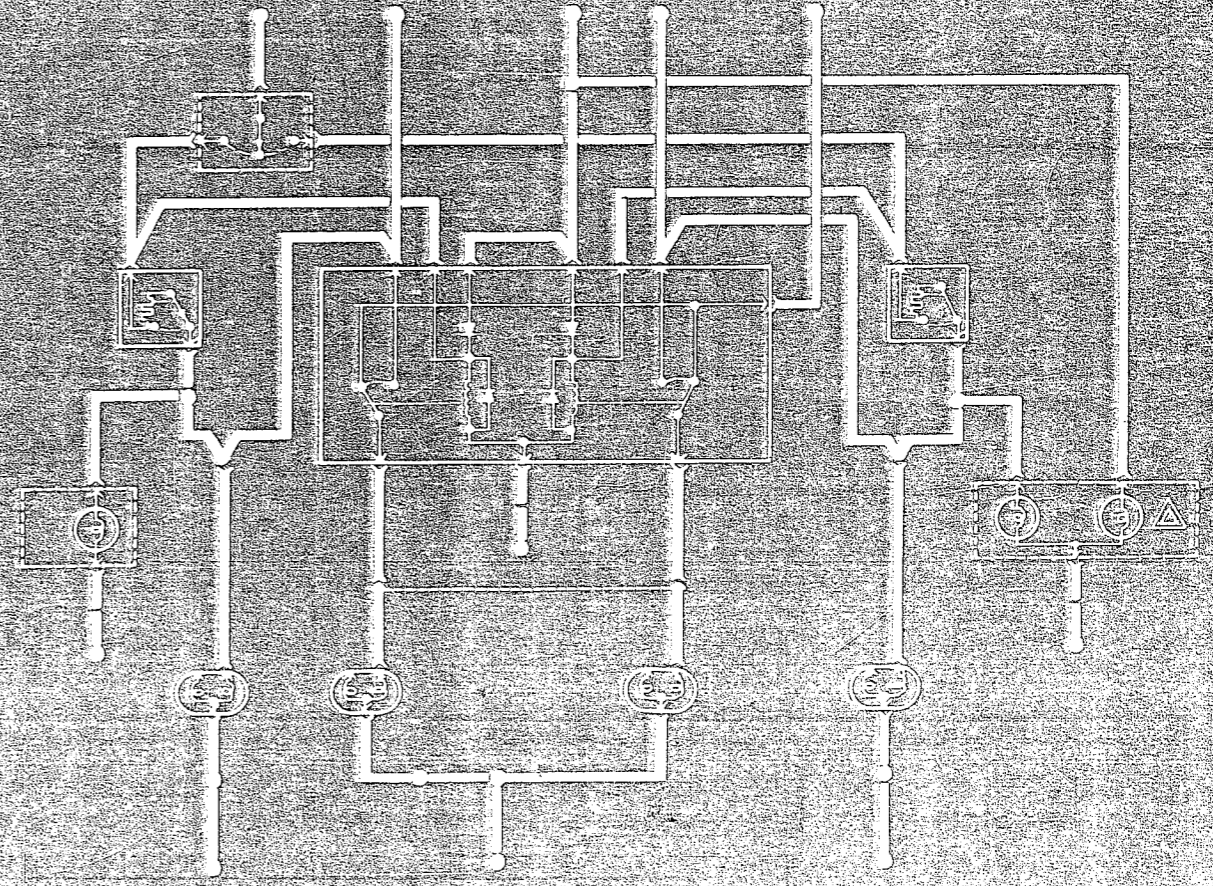

COMANCHE

CONTENTS

ELECTRICAL TESTING TOOLS	2
INTRODUCTION	3
SYMBOLS	4
FUSE PANEL DATA	6
POWER DISTRIBUTION	7
GROUND DISTRIBUTION	10
SYSTEM SCHEMATICS	14
CONNECTOR END VIEWS	75
HARNESS ROUTING VIEWS	86
INSTRUMENT CLUSTER	96
SWITCH TESTING	98

SCHEMATIC INDEX

Air Conditioning — 2.5L	36	Lamps — Headlamps and Foglamps	66
Air Conditioning/Engine Cooling with A/C — 4L	37	Lamps — Instrument Panel	61
Charging System	24	Lamps — Interior	63
Chime Module	45	Lamps: Side Marker/Park/Tail/License	69
Clock	59	Lamps: Turn/Stop/Backup	71
Cruise Control	48	Power Distribution — 2.5L	7
Diagnostic Connectors	18	Power Distribution — 4L	8
Engine and Fuel Controls — 2.5L	14	Power Door Locks	52
Engine and Fuel Controls — 4L	16	Power Windows	54
Ground Distribution	10	Radio	56
Heavy Duty Cooling — 4L	41	Radio/Clock/Illumination	59
Horns	47	Starter	21
Instrument Cluster	29	Transmission Controls — 2.5L	19
Instrument Cluster/Indicators	28	Transmission Controls — 4L	20
		Wiper/Washer	42

HARNESS CODES

CODE	HARNESS	CODE	HARNESS
A	ALTERNATOR	FL	FRONT LAMPS
AC	AIR CONDITIONER	H	HEATER
B	BODY	IN	INJECTOR
BAT	BATTERY	IP	INSTRUMENT PANEL
CC	CRUISE CONTROL	T	TRANSMISSION
CL	CARGO LAMPS	TL	TAIL LAMPS
DL	DOME LAMP	LL	LICENSE LAMP
E	ENGINE	UB	UNDERBODY
EC	ENGINE CONTROL	LF	LEFT FRONT DOOR
FC	FRONT CROSSBODY	RF	RIGHT FRONT DOOR

WIRE COLOR CODES

CODE	COLOR	CODE	COLOR	CODE	COLOR
BLK	Black	GRY	Gray	VIO	Violet
BLU	Blue	ORN	Orange	WHT	White
BRN	Brown	PNK	Pink	YEL	Yellow
GRN	Green	RED	Red		

WIRE GAUGE CONVERSION CHART

Metric Size	Awg. Sizes	Metric Size	Awg. Sizes
.22	24	3.0	12
.35	22	5.0	10
.5	20	8.0	8
.8	18	13.0	6
1.0	16	19.0	4
2.0	14	32.0	2

ELECTRICAL TESTING TOOLS

The following tools, or their equivalents, can be used to perform the electrical tests in this manual.

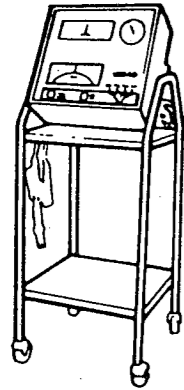

VOLT-AMP TESTER
PART NO. S-VAT-40 (AMSERV)

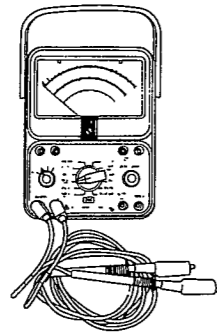

ANALOG MULTIMETER
PART NO. 8981320941

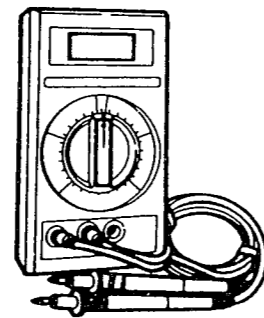

DIGITAL MULTIMETER
PART NO. 8980002456

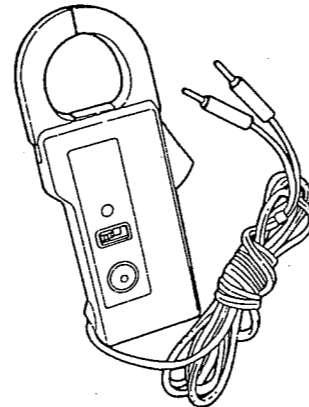

INDUCTIVE CURRENT CLAMP (USED WITH DIGITAL MULTIMETER)
PART NO. 8980002640

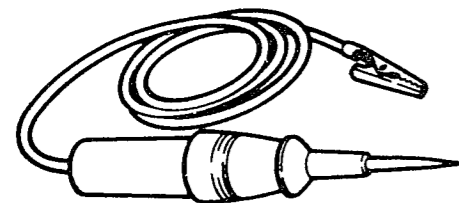

CONTINUITY LAMP
PART NO. 8980002500



TERMINAL PROBE SET
8980002638

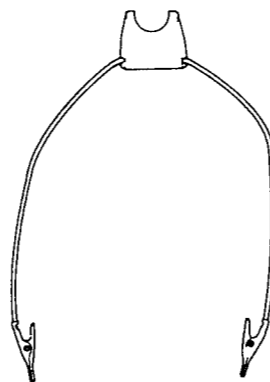

FUSED JUMPER WIRE
PART NO. 8980002639

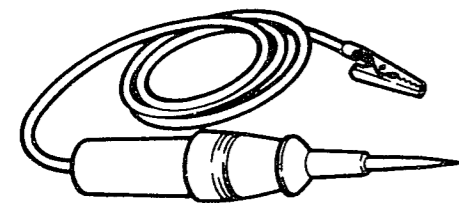

TEST LAMP
PART NO. 8980002686

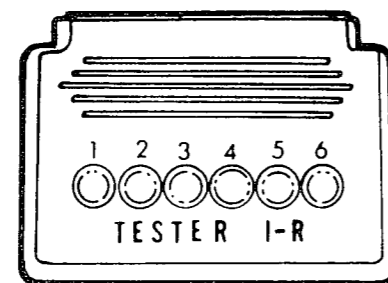

AM PC-1-R TESTER
PART NO. 8981320815

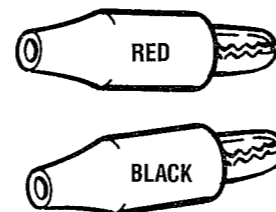

ALLIGATOR CLIPS (USED WITH TERMINAL PROBE SET)
PART NO. 8980 002 689

The following descriptions detail the functions of an analog or digital multimeter. The illustrations show the switch settings and meter scales for the analog multimeter part no. 8981320941.

VOLTS RANGE

The volts range is set by rotating the range selector knob on the meter to the desired voltage range. The meter can be switched between A.C. volts and D.C. volts using the switch on the LH side of the meter. There are two leads. The *red* lead is *positive* and is connected to the voltage source. The *black* lead is *negative* and is connected to ground. Voltmeters, like test lights, are always connected in *parallel* with the circuit being tested.

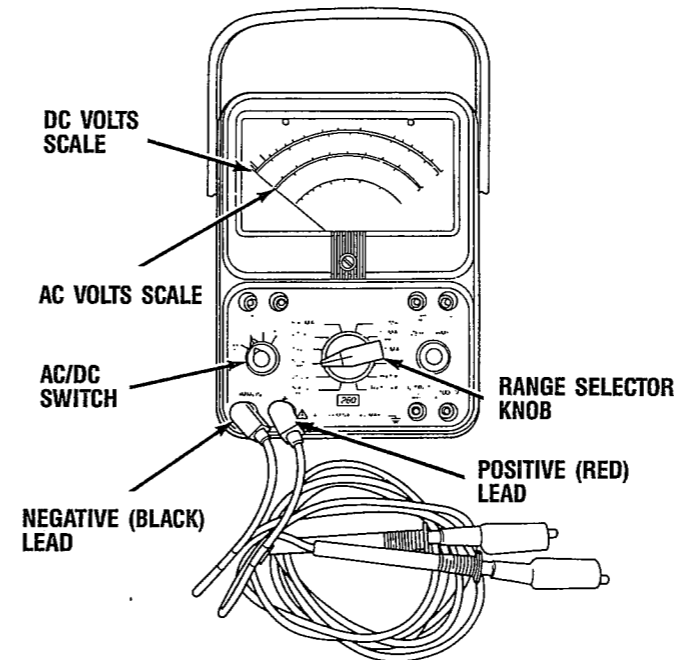

AMPS RANGE

The amps range is used to measure the amount of current. The range selector knob is set to the desired amp range. Always start with the highest range. The leads are connected in *series* with the circuit. There are two leads. The *red* lead (*positive*) is connected towards the voltage source. The *black* lead (*negative*) is connected towards ground. Remember, the circuit has to be opened and the ammeter is inserted in *series*.

NOTE: The Volt-Amp tester and the inductive current clamps are capable of measuring up to 600 amps. The analog multimeter can accurately measure up to 10 amps.

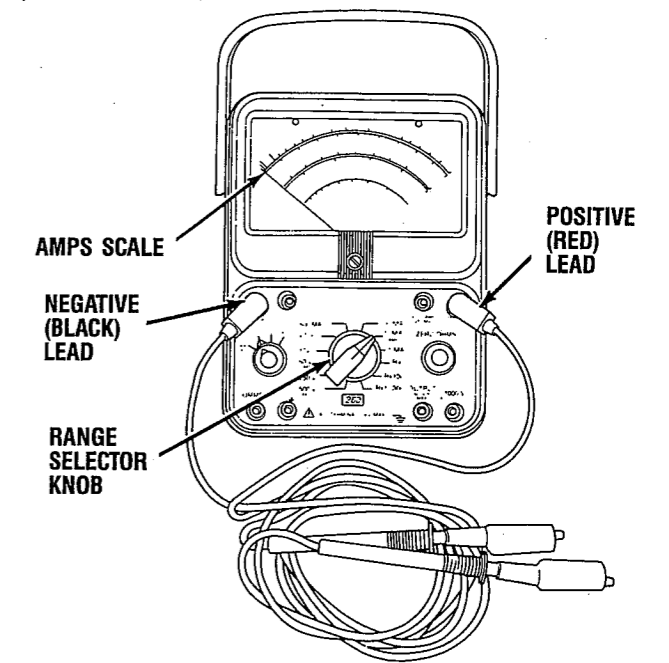

OHMS RANGE

The ohms range is used to measure resistance. The following procedure is recommended.

- 1) Ensure that the power is OFF before measuring resistance.
- 2) When using an analog multimeter, bring the test leads together and adjust the *zero adjust* knob until the needle reads *zero*. If unable to adjust to zero, replace the internal batteries.
- 3) Connect the leads, one on each side of the resistance. Multiply the *meter reading* by the *multiplier setting* on the range selector knob to find the circuit resistance in order to read the resistance.

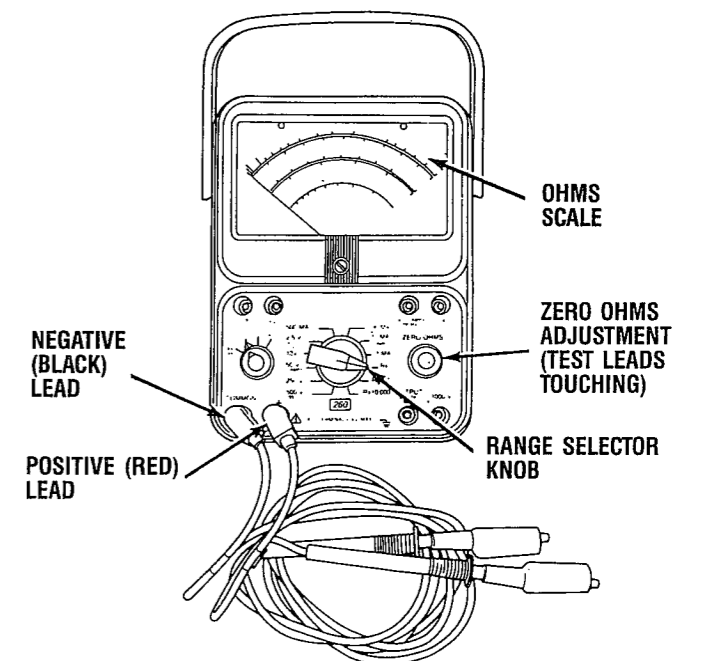

INTRODUCTION

HOW TO USE THIS MANUAL

This manual contains the schematics and related information necessary to troubleshoot electrical problems on the vehicle.

The Schematic Index lists the page on which a circuit starts. The information for each circuit includes the Schematic, a Description of the system, Troubleshooting charts and Testing. The harness routing illustrations at the rear of the manual show the components splice locations.

Schematics

The schematic includes all of the electrical components, wires, wire splices and grounds associated with the circuit. The circuits are arranged so that current flows from positive, at the top of the page, to negative at the bottom of the page. (The conventional theory of current flow is used in this manual.)

The HOT labels above the fuses or switches at the top of the page show the source of power supply to that component.

All components are shown in the OFF, "at rest" or normally closed position. Components names are shown beside the components. Additional information is also shown below the component name describing how the component works.

Transistorized components are labeled "solid-state." Some components are part mechanical and part solid-state (integrated circuits). Wiring inside complicated components has been simplified to make it easier to understand the electrical operation of the component.

Refer to the Symbols section of this manual for a sample schematic showing the various codes used for the wiring. Also included in the Symbols section are the Wire Color Codes and Harness Code Charts.

Description

The circuit descriptions provide additional information on circuit operation. Follow the schematic while reading the circuit description, to understand how the circuit works.

Troubleshooting

The troubleshooting charts are divided into three columns. The TEST column lists the components or connector terminal to be tested. The OK column lists the result if the circuit or component is operating correctly. If the test is OK, proceed to the next column. The NOT OK column lists the action to take if the component did not pass the test.

Testing

The Testing portion of the manual covers detailed component or system testing using the specified test equipment. This includes switch continuity tests or system testing, as in the case of the S-VAT-40 Volts-Amps Tester for the starter system.

Connector End Views

The connector end views are shown in numerical sequence starting with C100. The location of the connector in the vehicle is included with the connector number.

Harness Routing Views

The illustrations show a detailed view of the various harnesses throughout the vehicle. These illustrations include connector ground and splice locations.

FIVE-STEP TROUBLESHOOTING PROCEDURE

A good troubleshooting procedure saves time and effort and aids in finding the trouble. There are five logical steps that should be followed:

STEP 1: Verify the Complaint.

If a customer complains of a specific problem, find out if the problem really exists. If the customer complains the horn does not work, verify the complaint by depressing the horn button and listening for the beep. This action of depressing the horn button is called an operational check. When performing operational checks, look for symptoms; both positive and negative. Remember! Operational checks are made without the use of test equipment.

Positive Symptoms are symptoms which are correct. For example, the radio plays when the radio switch is turned on.

Negative Symptoms are symptoms which are incorrect. For example, the horn does not blow when the horn button is depressed.

If a question arises as to how a circuit operates, refer to the schematic and description. The layout of the schematic simplifies all circuit operations.

Sometimes a problem may be intermittent (momentarily present and not present). If so, road test the vehicle, with the customer if possible, having him or her demonstrate what happens. Try to duplicate the conditions in order to make the problem appear. The problem cannot be found if everything works normally. When the problem occurs, note the symptoms. Remember! Both the positive and negative symptoms are important.

STEP 2: Isolate the Problem

After determining that the problem exists, isolate the problem to a specific area by performing operational checks on related circuits. By using the circuit schematic, and the power distribution and grounds schematics if necessary, determine other circuits which are connected to the problem circuit. By performing operational checks on these circuits, the problem area can be isolated.

Example (Refer to Fig. 1):

If the customer complaint is that the Backup Lamps do not work, trace the circuit starting at ground to the first common point (A). As shown, the Windshield Wiper and Seat Belt Timer circuits are also connected to point A. Therefore, conduct operational checks on these circuits to see if they operate. If they do (positive symptoms), the next step would be to proceed to Step 3 in the troubleshooting procedure.

If the battery circuit did not operate, continue tracing the circuit toward the Battery until the next common point (B) is reached. The A/C and Rear Window Defogger circuits are connected to point B. Therefore, they should be checked to see if they operate. If they do, proceed to Step 3.

If the Backup Lamps did not operate, but the Windshield Wiper did, the trouble would lie between point A and ground at the Backup Lamps. The problem may be an open, since a short would have caused Fuse F15 to open, and the Windshield Wiper and Seat Belt Timer would not operate.

If the Backup Lamps, Windshield Wiper, and Seat Belt Timer did not operate, but the A/C and Rear Window Defogger did, the trouble would lie between point B and ground. The problem would lie between point B and ground. The problem may be a short. For example, fuse F15 may have opened due to a short in the Backup Lamps, Windshield Wiper/Washer, or Seat Belt Timer circuits.

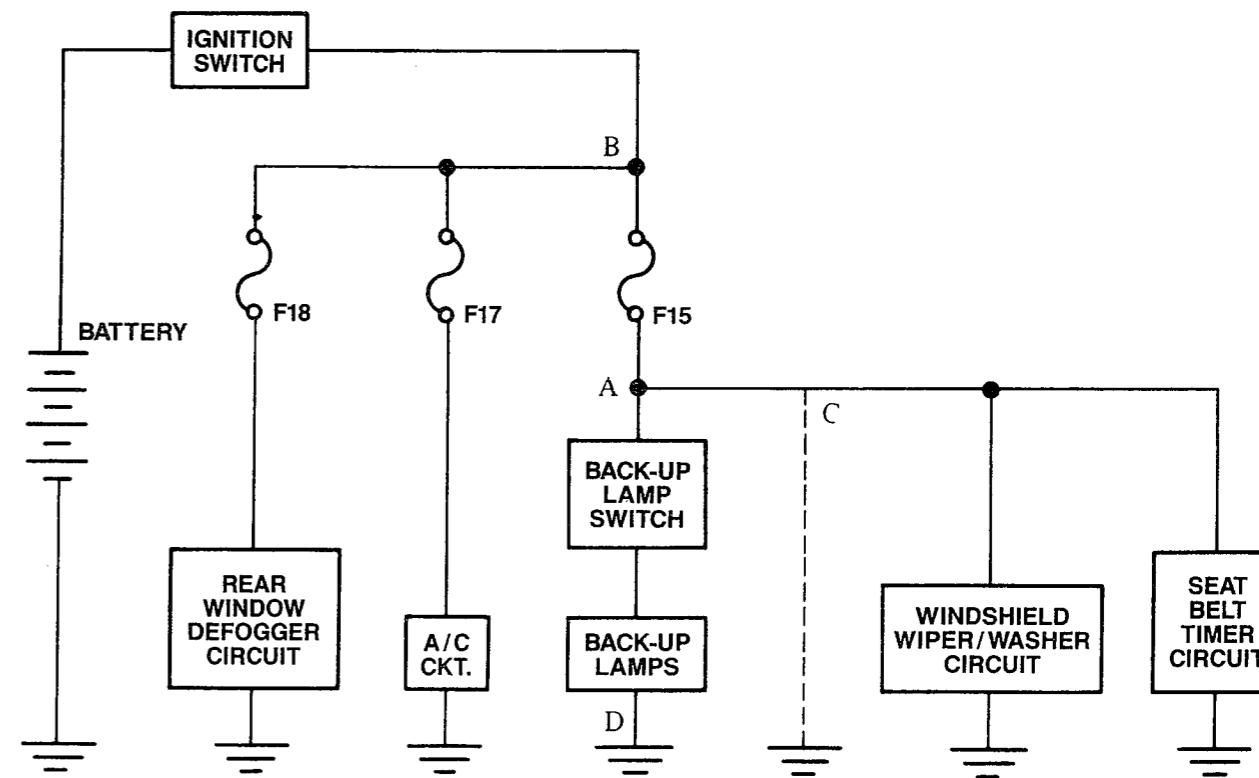

Fig. 1

INTRODUCTION

STEP 3: Test the Circuit

Step 1 and 2 of the troubleshooting procedure can be performed without removing any components from the vehicle or using test equipment. After isolating the problem, testing of the circuit may be started. When testing the circuit, there are two important things to consider:

- What goes wrong most of the time? Some parts receive more use than others and therefore wear out sooner. Other parts, such as grounds are subjected to corrosion.
- How difficult the parts are to access determines the order in which they should be checked. Leave the more difficult places until last.

Electrical problems are mainly caused by either open or short circuits.

Open Circuit

An open circuit is like an open switch. It interrupts the flow of current. An open circuit has an infinite resistance (∞); therefore, no current will flow. Open circuits may be caused by broken wires, parts being worn or damaged, loose connections, (like ground screws), and by foreign matter being stuck between contacts.

Intermittent open circuits can be caused by oxidation between two contacts, or by loose connectors or terminals, resulting in poor terminal contact.

Short Circuit

This is a condition that occurs when a wire or an internal circuit of a component is connected directly to ground.

A short circuit in a power circuit allows excessive current to flow because of the resistance of the circuit going to zero ohms. This usually results in a blown fuse or circuit breaker.

A short circuit in a ground circuit could allow a component to operate when it is not supposed to. An example of this is the rear seat cut-out switch for the power windows. (Refer to the Power Window Schematic). If a ground wire between the cut-out switch and the rear window switches were to short circuit, that window could still be operated, whether or not the cut-out switch was off.

After isolating the problem and developing a plan, use the schematic, test equipment, connector and harness views to locate the problem.

If difficulty is encountered while trying to locate a problem, use the troubleshooting charts and testing procedures. They follow a step-by-step procedure that is designed to aid the technician.

It may be necessary to remove other components to gain access to the components being tested. Refer to appropriate M.R. (Repair Manual) for these procedures.

STEP 4: Correct the Problem

After locating the problem, correct it by repairing or replacing the faulty wiring or component.

STEP 5: Check for Proper Operation

After completing repair and before installing any trim panels or components removed for testing, check the system to ensure it is operating properly.

SWITCH TESTING

The switch testing at the end of the manual provides continuity testing of various switches in the vehicle. Included with each switch test is an internal switch schematic, an external view of the switch showing terminal positions and a switch test chart.

The POSITION column in the charts tells which position the switch should be in (OPEN, UP, etc.). The TERMINAL column tells which terminals to measure across from continuity. On switches with pigtails, the connector number also is shown. The ZERO OHMS column indicates whether the switch should have continuity (YES) or not have continuity (NO). If the switch does not pass the test, it should be replaced.

For switches with illumination bulbs, the bulbs can be replaced.

SYMBOLS

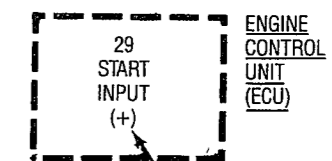
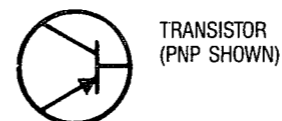
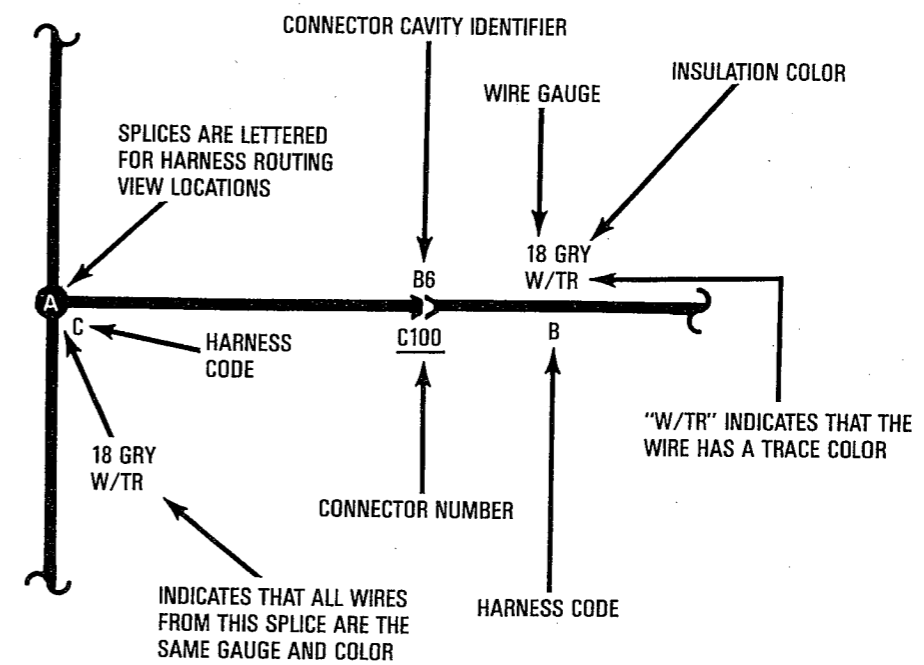

INDICATES WHETHER POSITIVE OR NEGATIVE SIGNAL USED TO CONTROL CIRCUIT

SYMBOLS



ENTIRE COMPONENT SHOWN



PART OF A COMPONENT SHOWN



NAME OF COMPONENT
DETAILS ABOUT COMPONENT OR ITS OPERATION



COMPONENT CASE IS DIRECTLY ATTACHED TO METAL PART OF VEHICLE (GROUNDED)



WIRE IS ATTACHED TO METAL PART OF VEHICLE (GROUNDED)

GROUND IS NUMBER FOR REFERENCE ON COMPONENT LOCATION TABLE

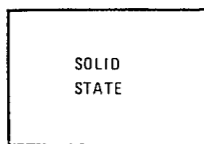

SOLID STATE (INCLUDES ONLY ELECTRONIC PARTS) SYMBOLS INSIDE BOX MAY SHOW FUNCTIONS

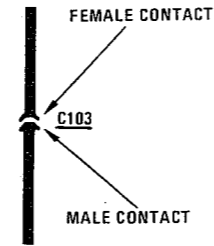

CONNECTOR REFERENCE NUMBER FOR COMPONENT LOCATION TABLE

TABLE ALSO SHOWS TOTAL NUMBER OF CONTACTS POSSIBLE: C103(6 CAVITIES)



CONNECTOR ATTACHED TO COMPONENT



CONNECTOR ON COMPONENT LEAD

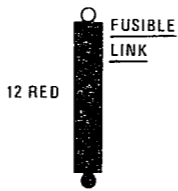

WIRE SIZE AND INSULATION COLOR ARE LABELED

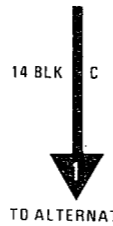

CURRENT PATH IS CONTINUED AS LABELED THE ARROW SHOWS THE DIRECTION OF CURRENT FLOW AND IS REPEATED WHERE CURRENT PATH CONTINUES



A WAVY LINE MEANS A WIRE IS TO BE CONTINUED/ OR WILL NO LONGER BE USED



CIRCUIT BREAKER

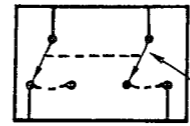

SWITCHES THAT MOVE TOGETHER

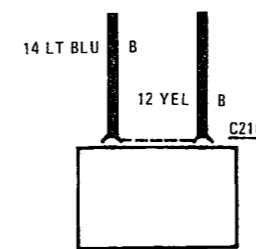

TWO TERMINALS IN THE SAME CONNECTOR

DASHED LINE SHOWS A PHYSICAL CONNECTION BETWEEN PARTS (SAME CONNECTOR)

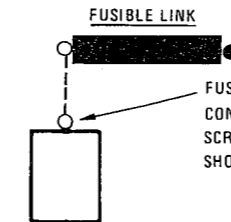

FUSIBLE LINK CONNECTS TO SCREW TERMINAL SHOWN SEPARATED

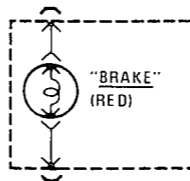

AN INDICATOR WHICH DISPLAYS THE LIGHTED WORD "BRAKE"

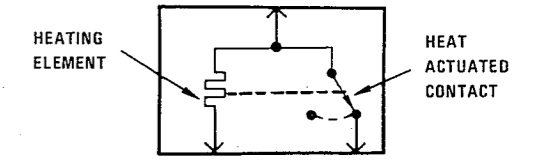

HEATING ELEMENT

HEAT ACTUATED CONTACT

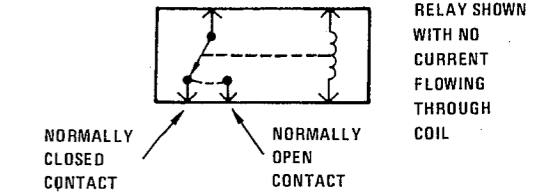

NORMALLY CLOSED CONTACT

NORMALLY OPEN CONTACT

RELAY SHOWN WITH NO CURRENT FLOWING THROUGH COIL

WHEN CURRENT FLOWS THROUGH COIL, CONTACT MOVES FROM NORMALLY CLOSED TO NORMALLY OPEN POSITION

HOW IN ACCY AND RUN FROM IGNITION SWITCH

INDICATES THAT POWER IS SUPPLIED WITH IGNITION SWITCH IN ACCY AND RUN POSITIONS

RADIO (GRN)

COLOR OF FUSE BLOCK CONNECTOR

LABEL OF FUSE BLOCK CONNECTOR CAVITY

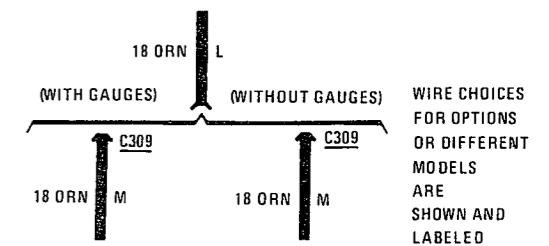

WIRE CHOICES FOR OPTIONS OR DIFFERENT MODELS ARE SHOWN AND LABELED

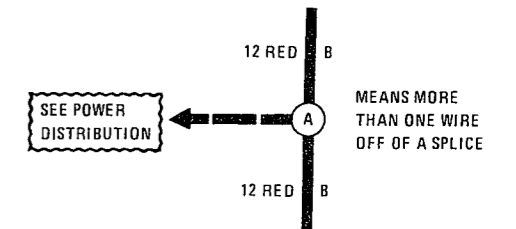

MEANS MORE THAN ONE WIRE OFF OF A SPLICE

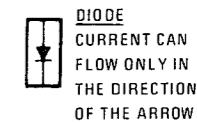

DIODE CURRENT CAN FLOW ONLY IN THE DIRECTION OF THE ARROW

FUSE PANEL DATA

NAME	COLOR SIZE (AMPS)	CIRCUITS PROTECTED
BLOWER	WHT (25)	BLOWER MOTOR CONTROLS
CLOCK	RED (10)	DIGITAL CLOCK, EMISSION MAINTENANCE TIMER
DOME	RED (10)	INTERIOR LAMPS
ETR	RED (10)	RADIO, CLOCK
GAUGES	VIO (7.5)	CHIME MODULE, CRUISE CONTROL, INSTRUMENT CLUSTER, HEADLAMP DELAY MODULE
HAZ/STOP	LT BLUE (15)	HAZARD FLASHER BRAKE LAMPS
HD LP/DLY	WHT (25)	HEAD LAMP DELAY MODULE
HTD WDW	WHT (25)	NOT USED
INST LPS	TAN (5)	INSTRUMENT PANEL LAMPS
PARK	RED (10)	CHIME MODULE PARKING LAMPS, ILLUMINATION RELAY, CLOCK
POWER WINDOW CIRCUIT BREAKER	(30)	POWER WINDOWS
PWR ACCY CIRCUIT BREAKER	(30)	POWER DOOR LOCKS
RR WIPE	WHT (25)	NOT USED
TRANS (TCU)	VIO (7.5)	TRANSMISSION CONTROL UNIT, BACK UP LAMPS
RADIO	LT BLUE (15)	CIGAR LIGHTER, RADIO, CLOCK, VANITY LAMPS
WINDSHIELD WIPER/WASHER CIRCUIT BREAKER	(5.5)	WINDSHIELD WIPERS
TURN B/U	YEL (20)	TURN FLASHER
ABS BAT	—	NOT USED
MOTOR PUMP	—	NOT USED
ABS IGN	—	NOT USED

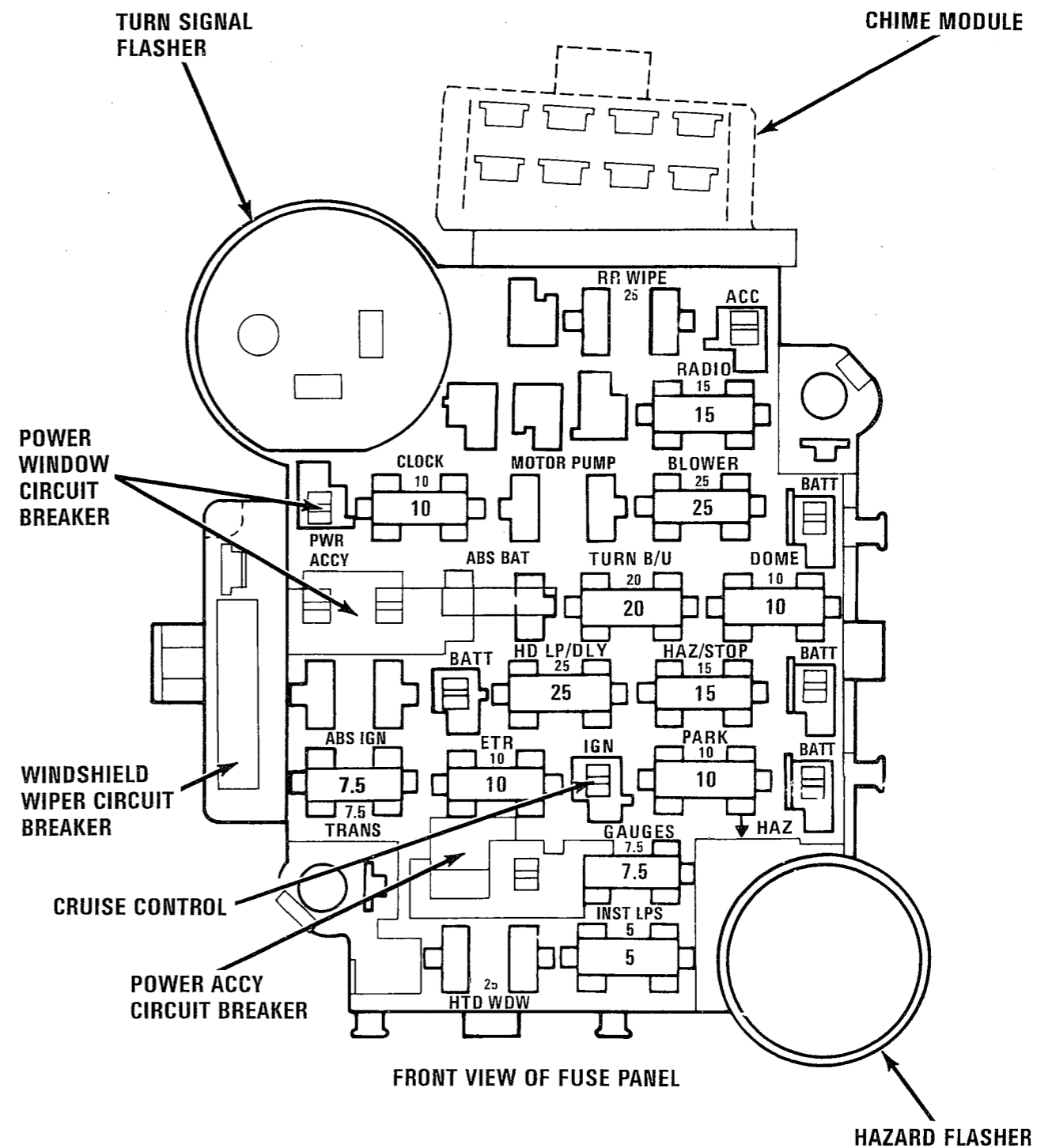

POWER DISTRIBUTION — 2.5L

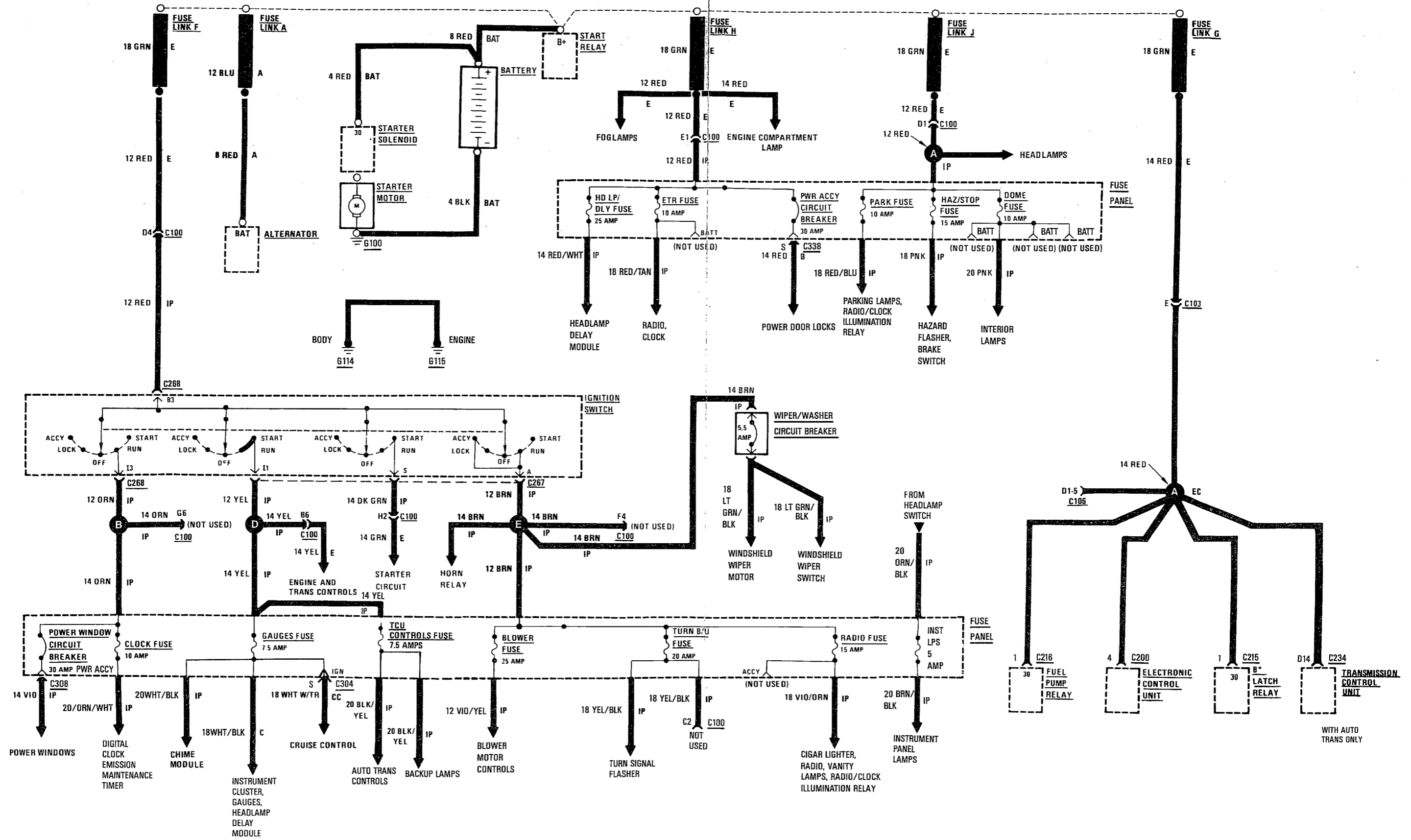

POWER DISTRIBUTION — 4L

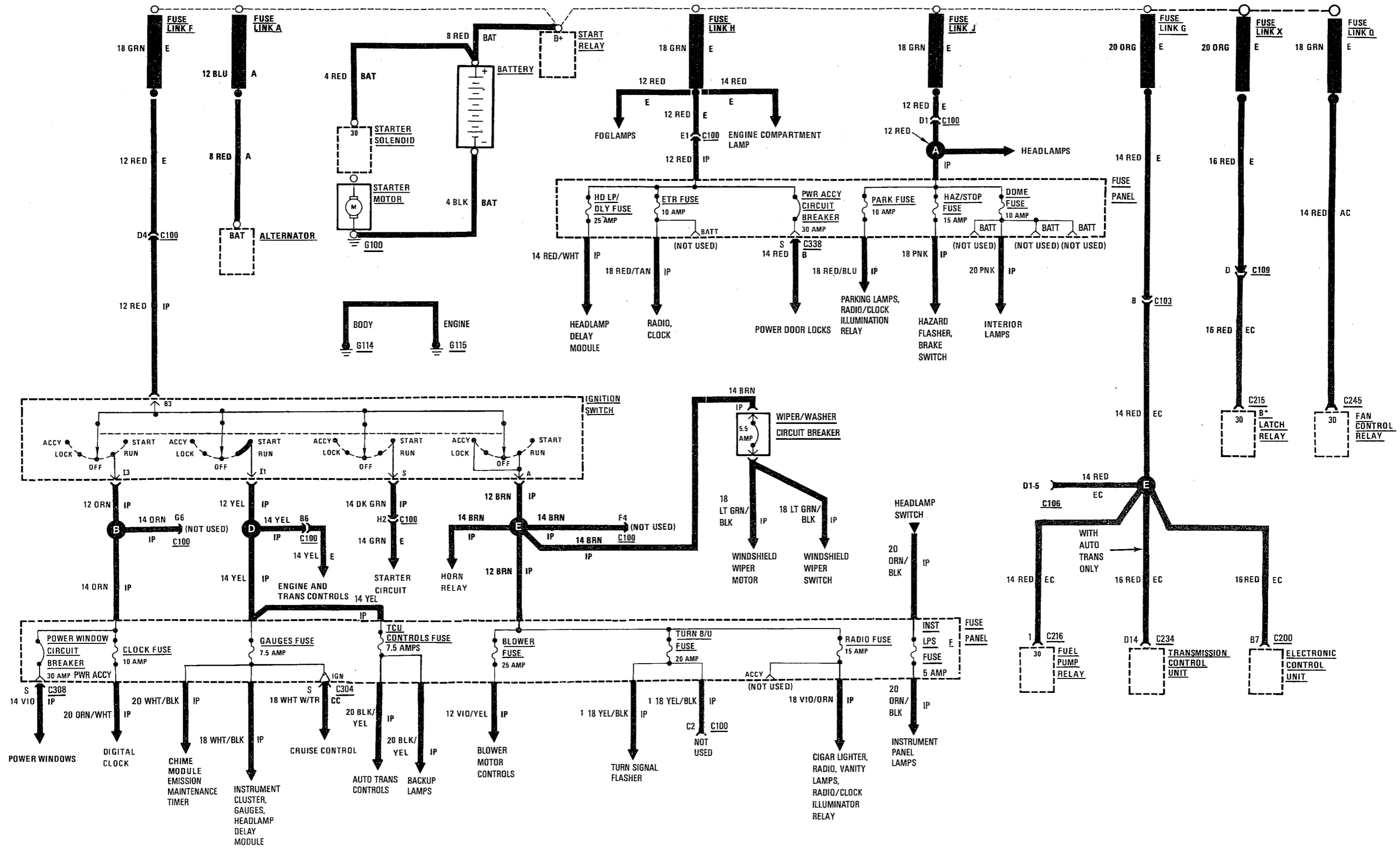

POWER DISTRIBUTION

CIRCUIT OPERATION

The power system consists of fuse links, fuses, circuit breakers, the light switch, and the ignition switch. Fuse links are short pieces of wire several gauge sizes smaller than the circuit wire to which they supply power. They are covered by a high temperature insulation. When high current is applied through them, they melt and stop current flow. Their function is to protect the car's electrical system from electrical shorts that are not protected by the circuit breakers and fuses.

The ignition switch is a 5-position switch. These positions are: ACC, LOCK, OFF, ON and START. On individual schematics, headings at the top of circuits will have hot bar references. These references will indicate ignition switch positions from which power is applied to the circuit. A HOT AT ALL TIMES reference means that battery voltage is directly applied to the circuit at all times.

GROUND DISTRIBUTION — 2.5L

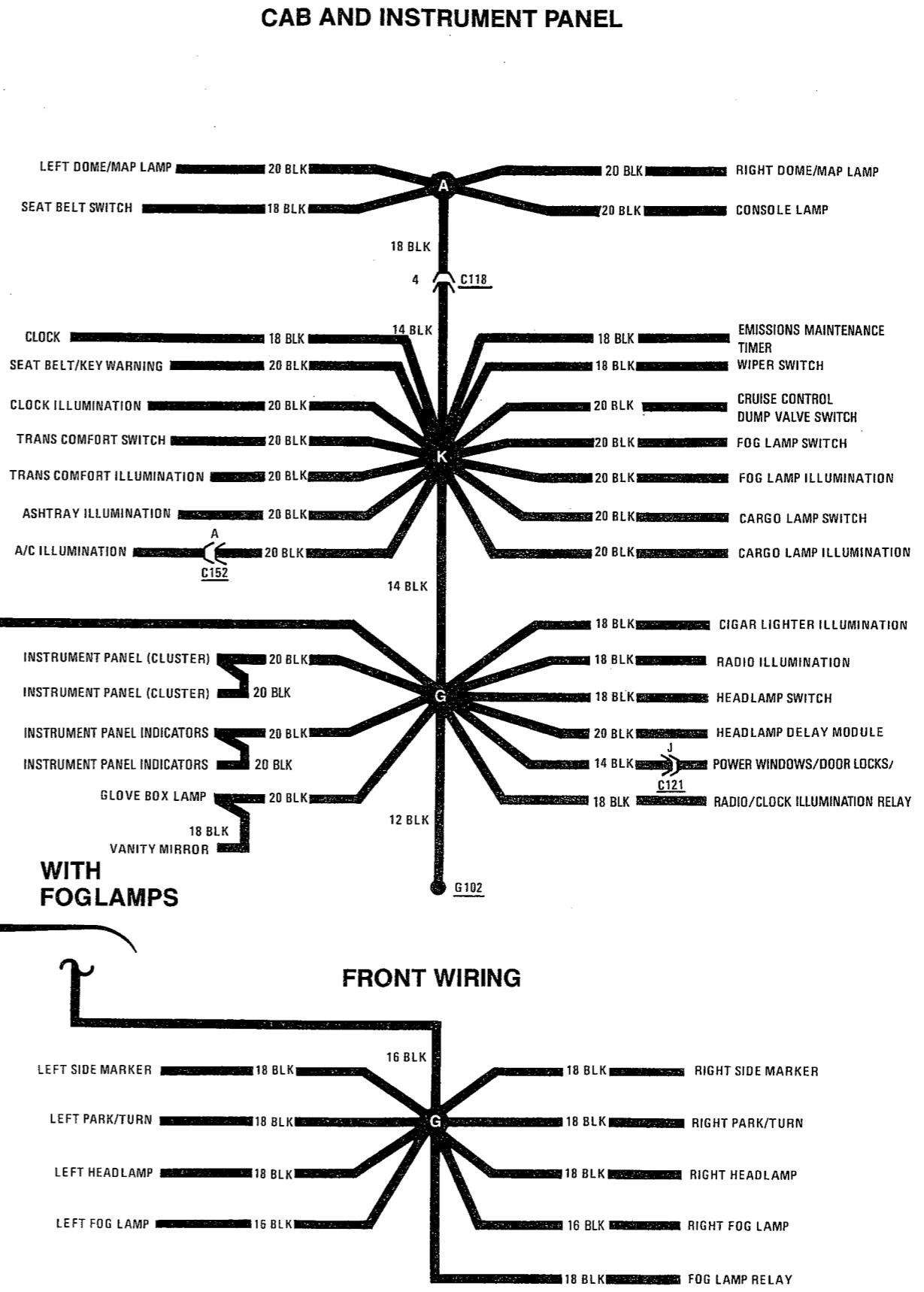
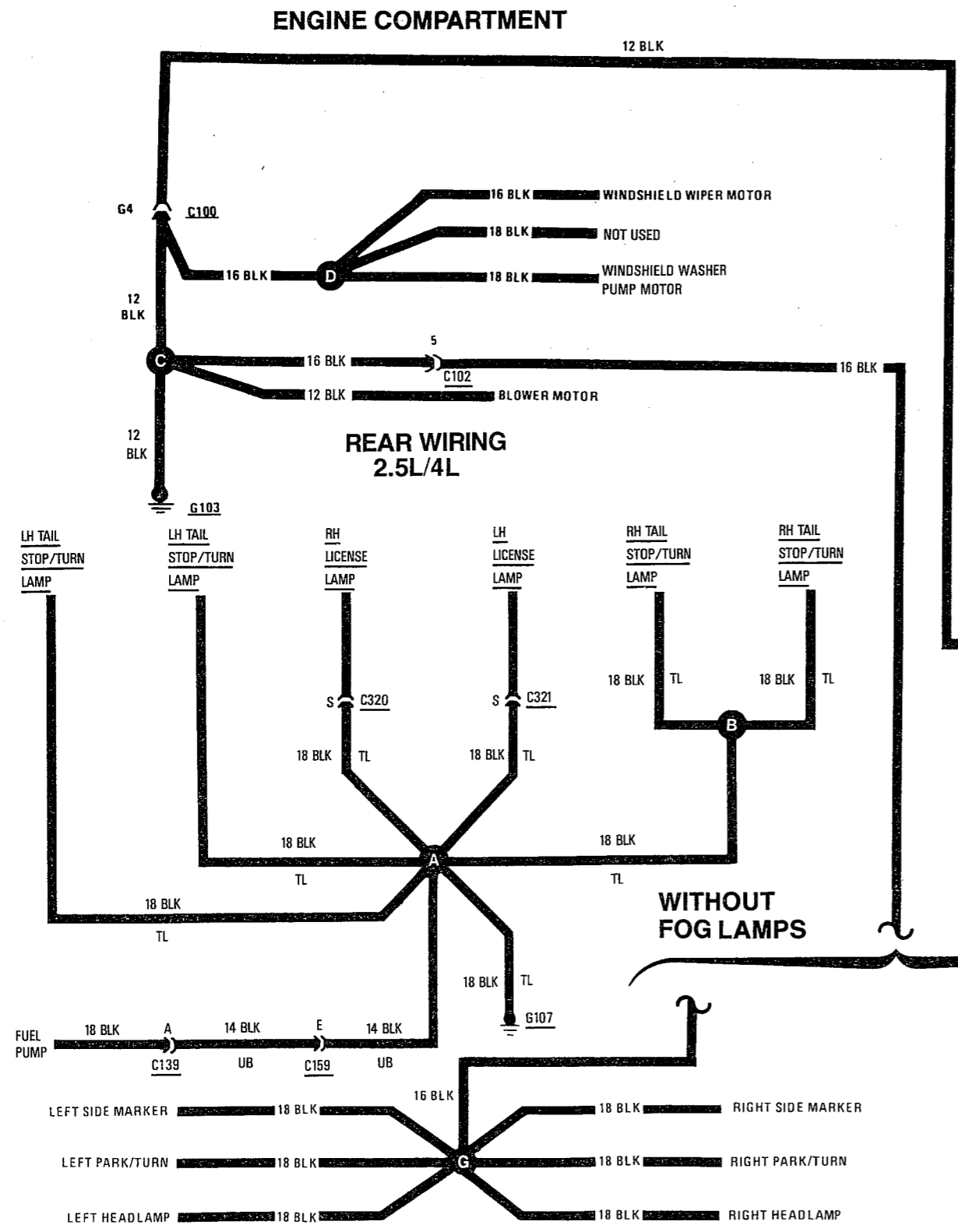

GROUND DISTRIBUTION — 2.5L

ENGINE AND CONTROLS

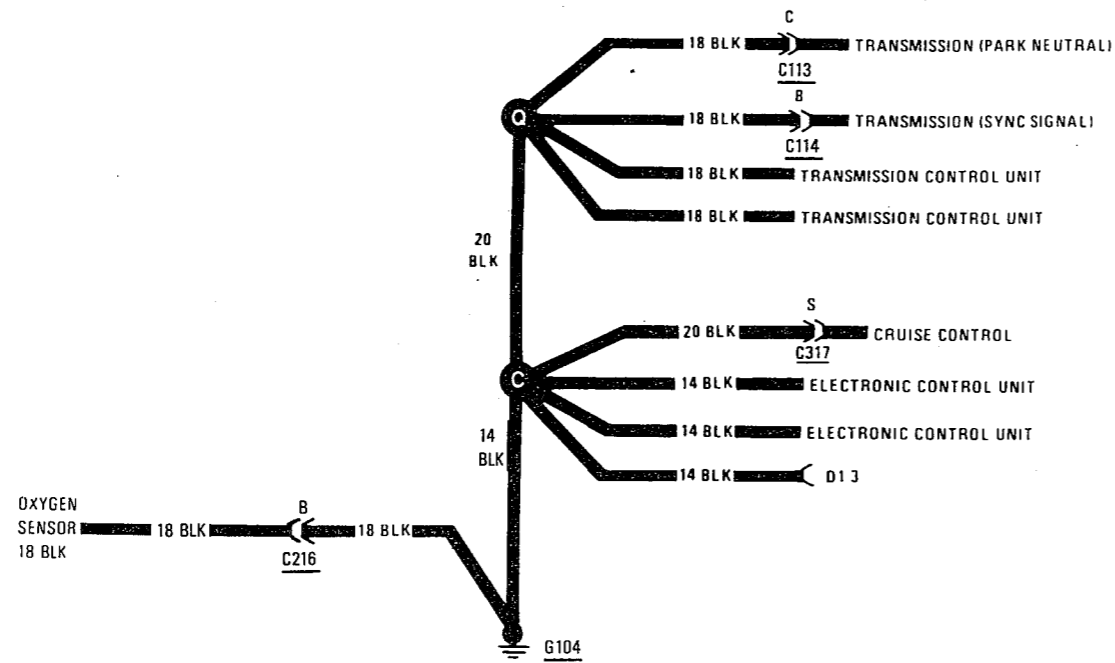

WITH AUTOMATIC TRANSMISSION

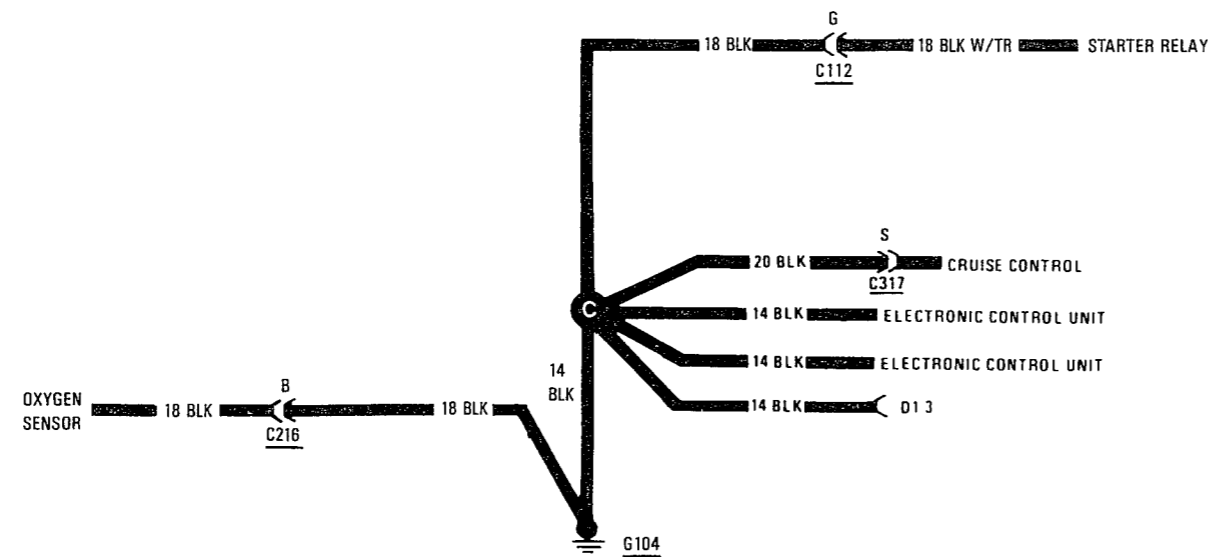

WITH MANUAL TRANSMISSION

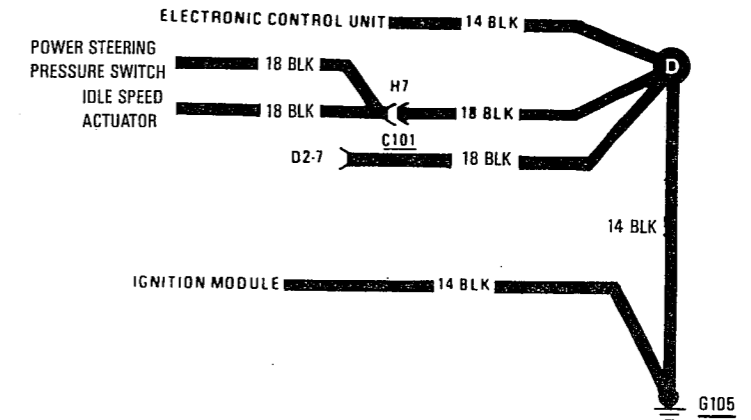

GROUND DISTRIBUTION — 4L

ENGINE COMPARTMENT

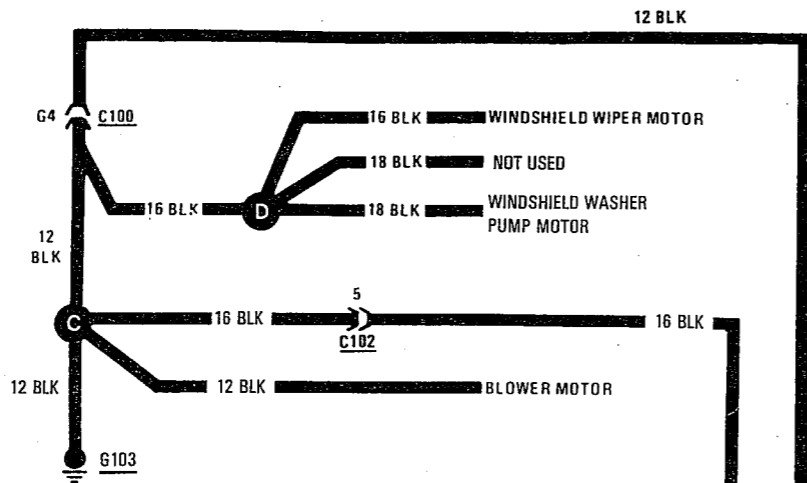

CAB AND INSTRUMENT PANEL

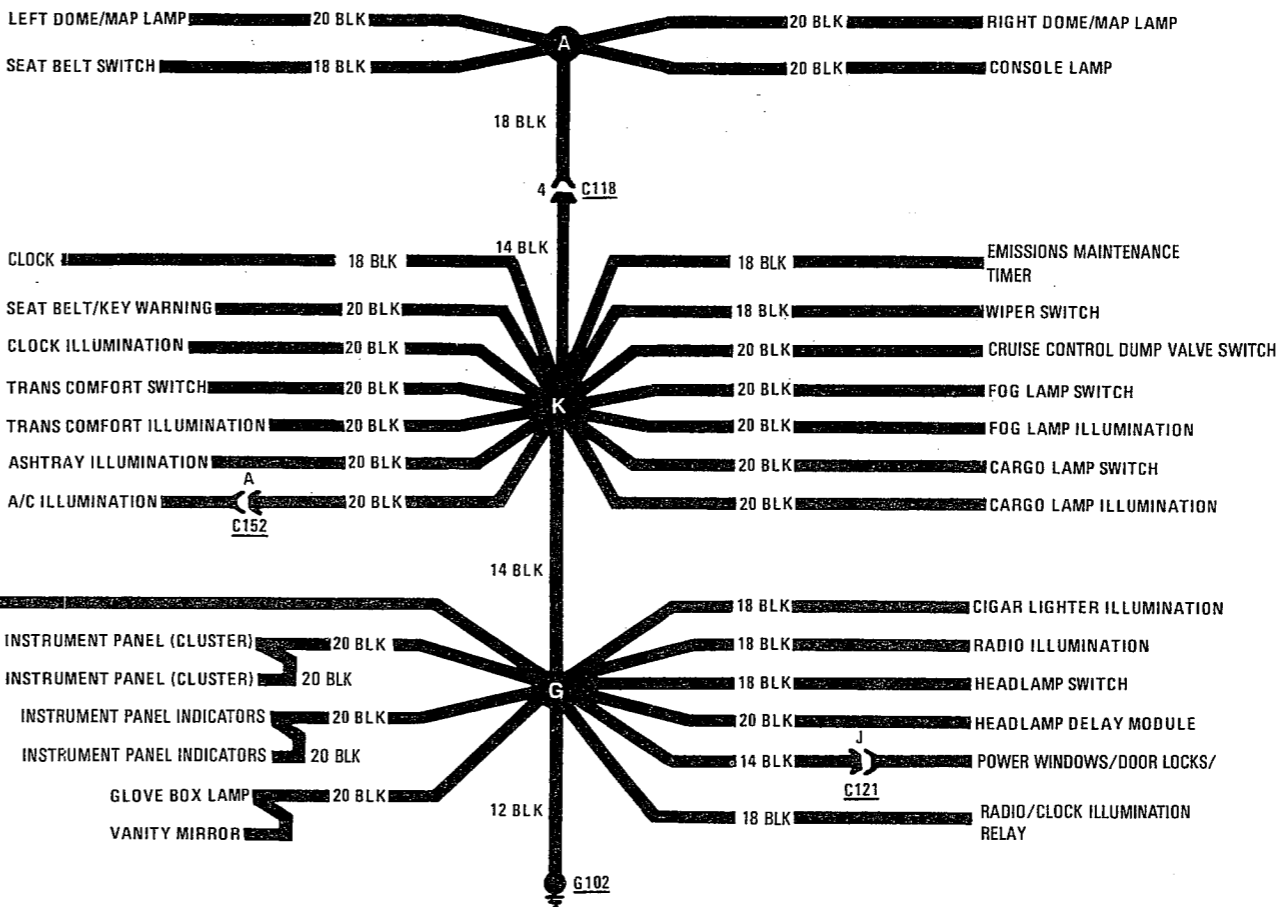

REAR WIRING 2.5L/4L

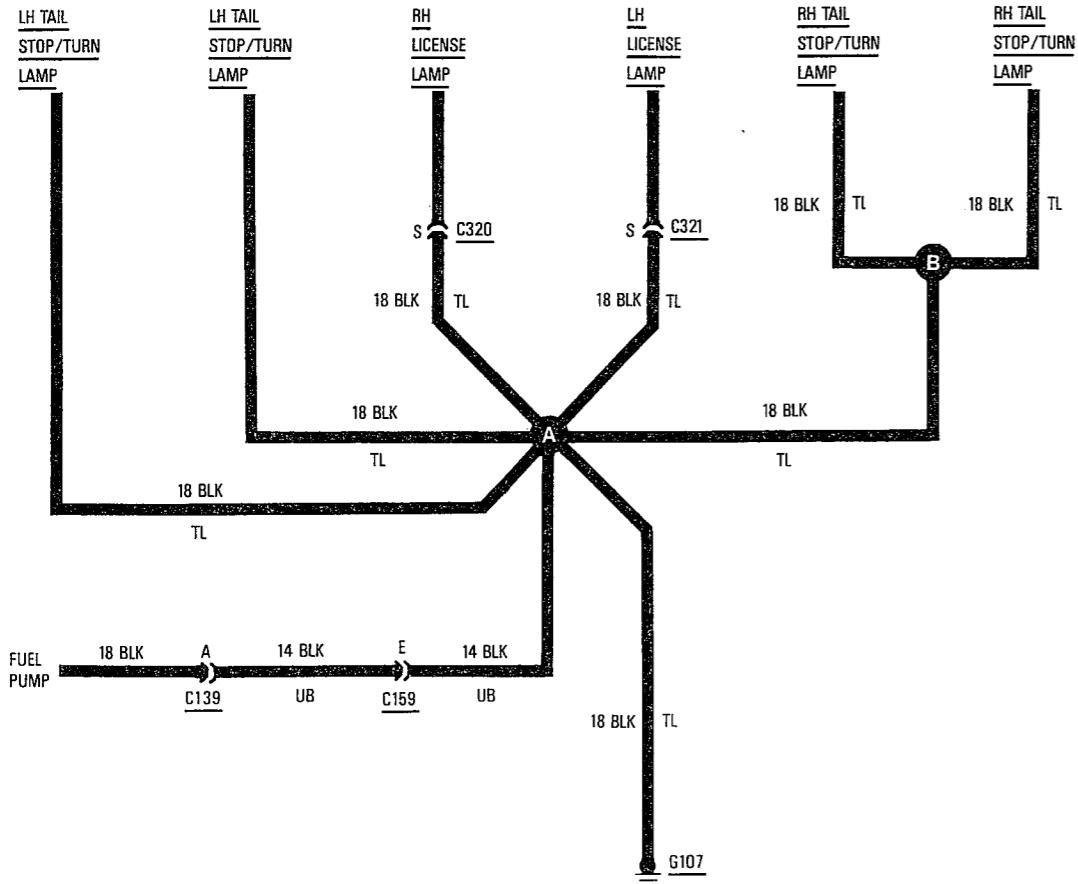

WITH FOG LAMPS

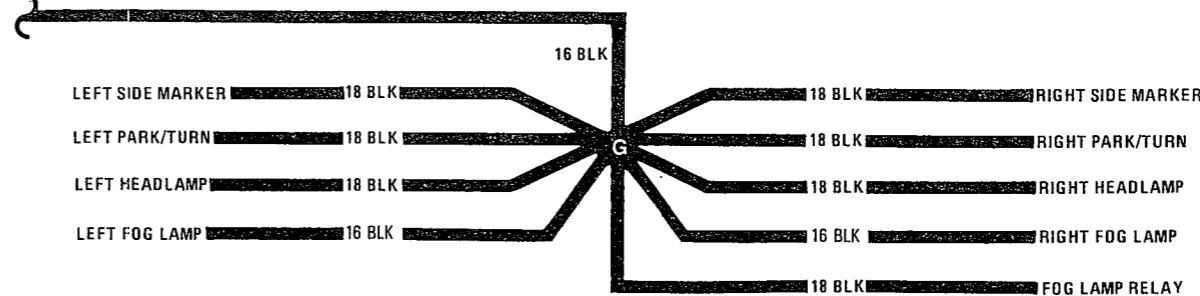

WITHOUT FOG LAMPS

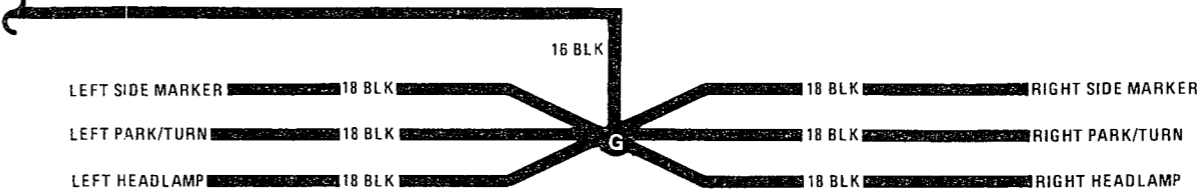

GROUND DISTRIBUTION — 4L

ENGINE AND CONTROLS

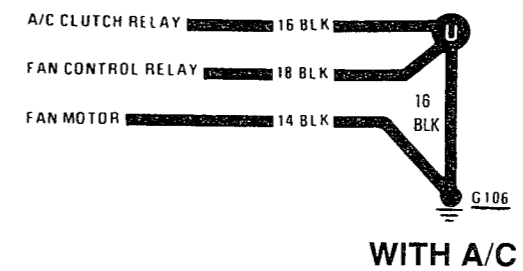
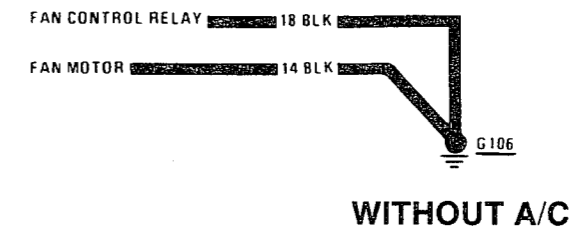
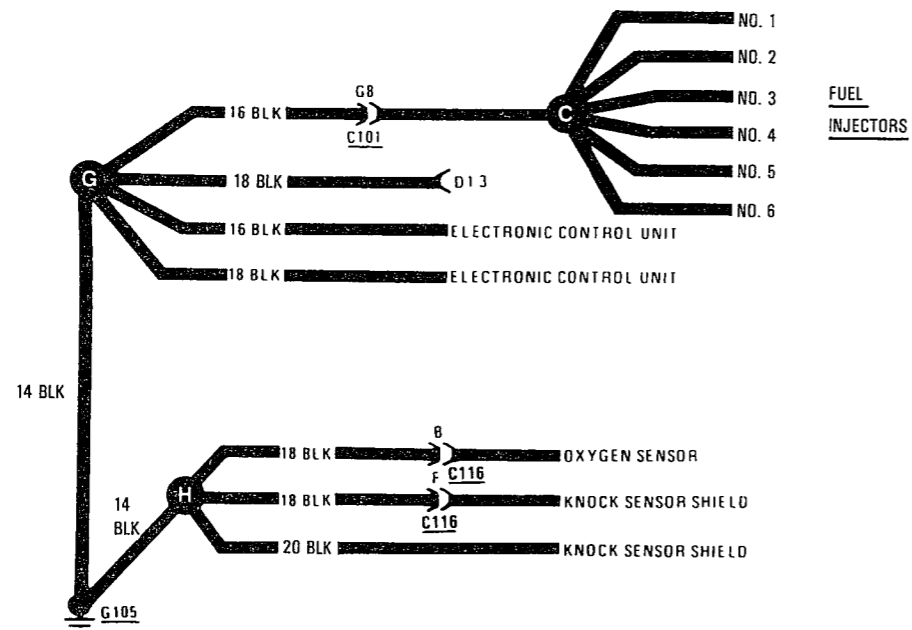
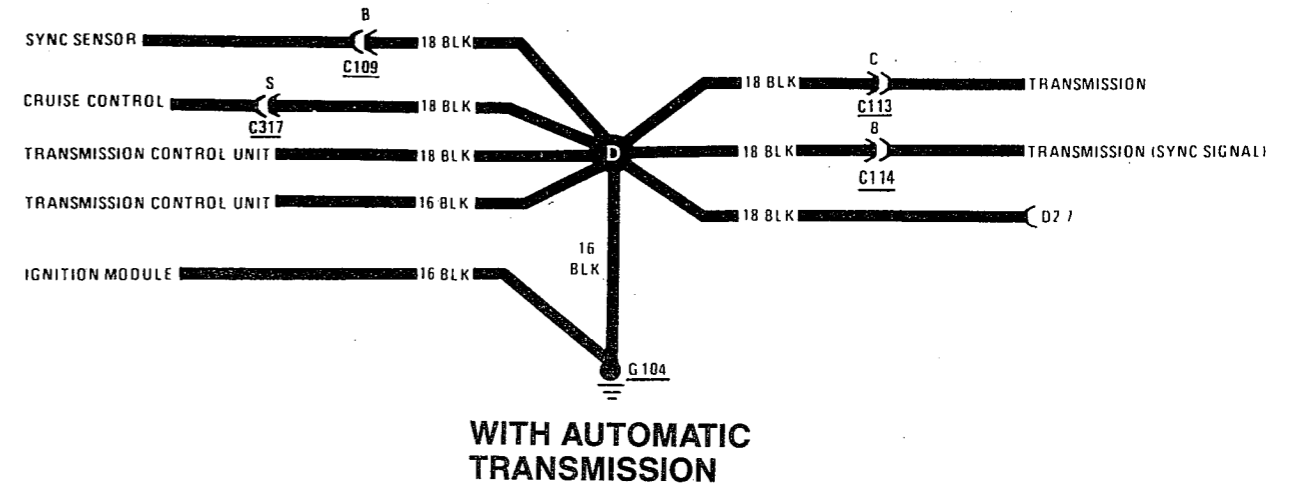
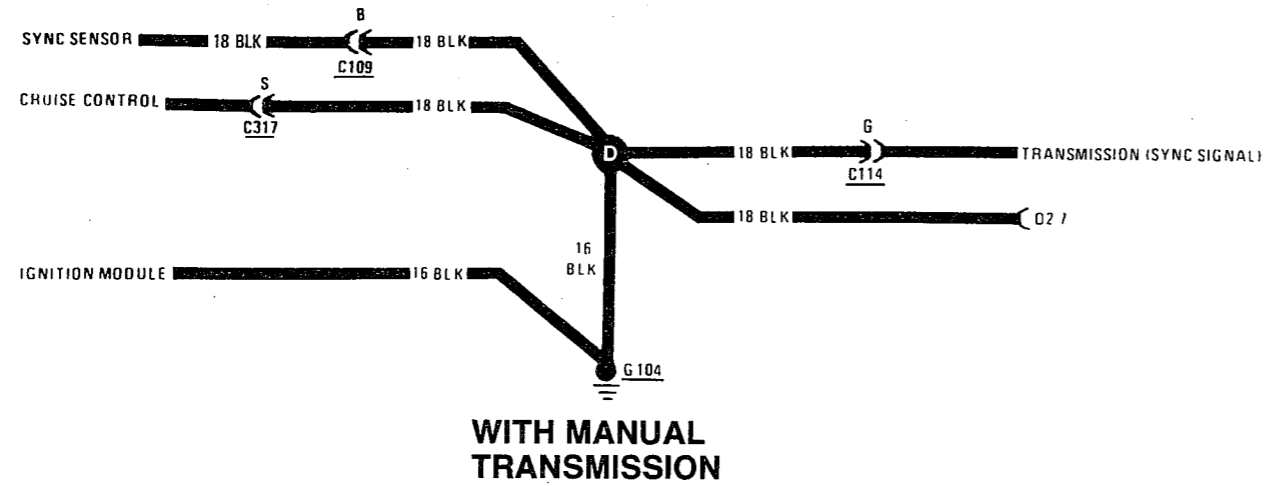

ENGINE AND FUEL CONTROLS — 2.5L

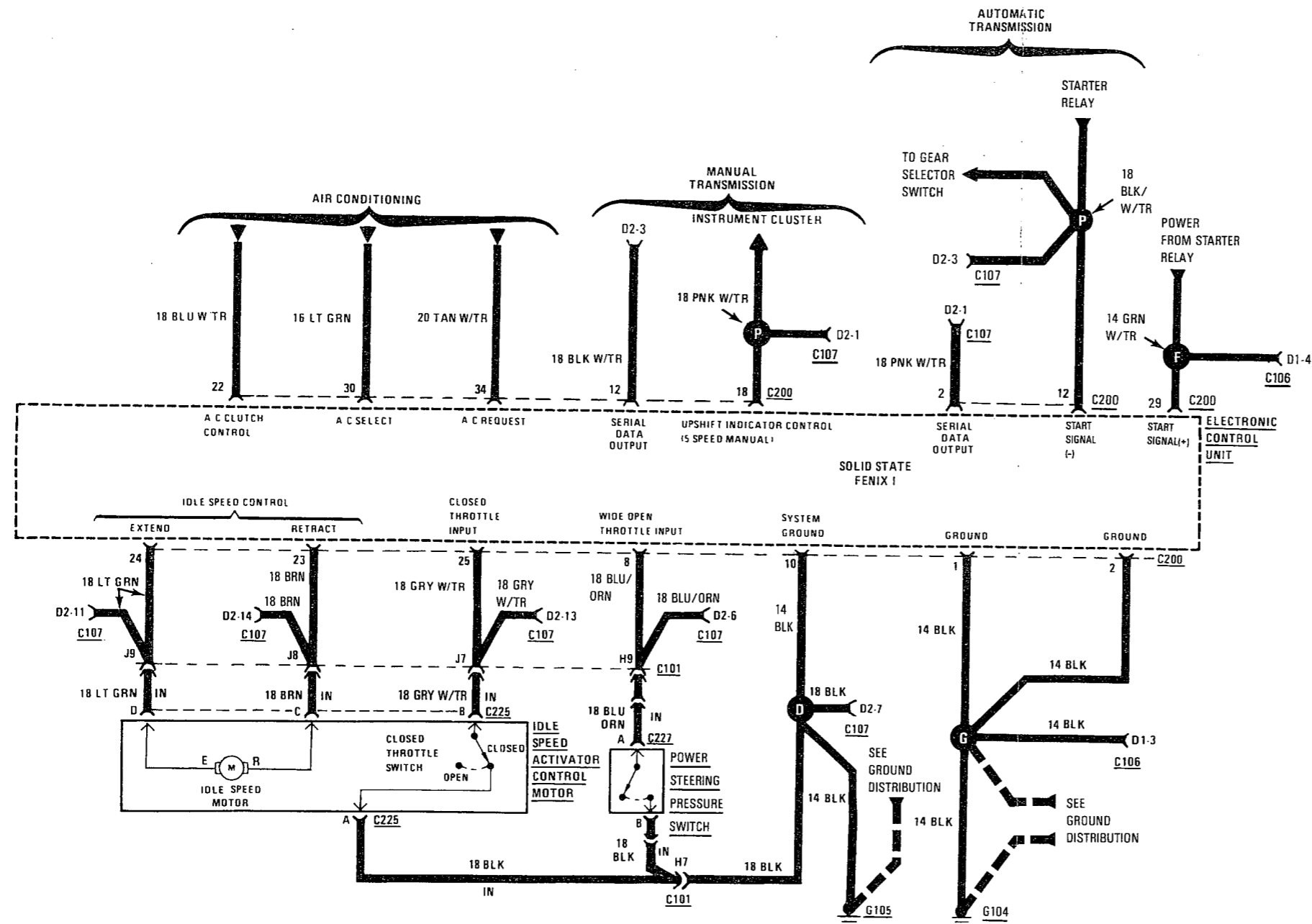

ENGINE AND FUEL CONTROLS — 4L

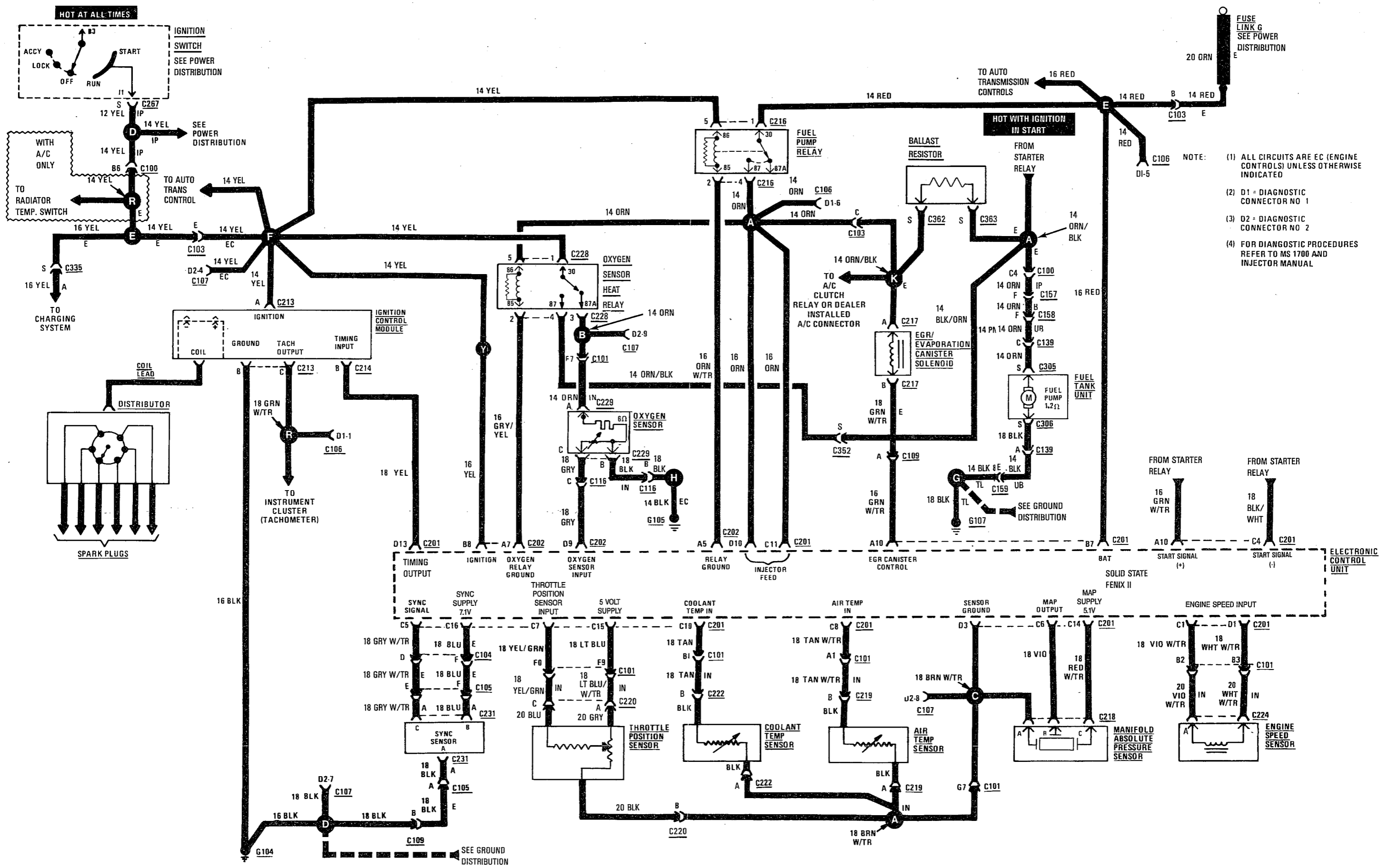

ENGINE AND FUEL CONTROLS — 4L

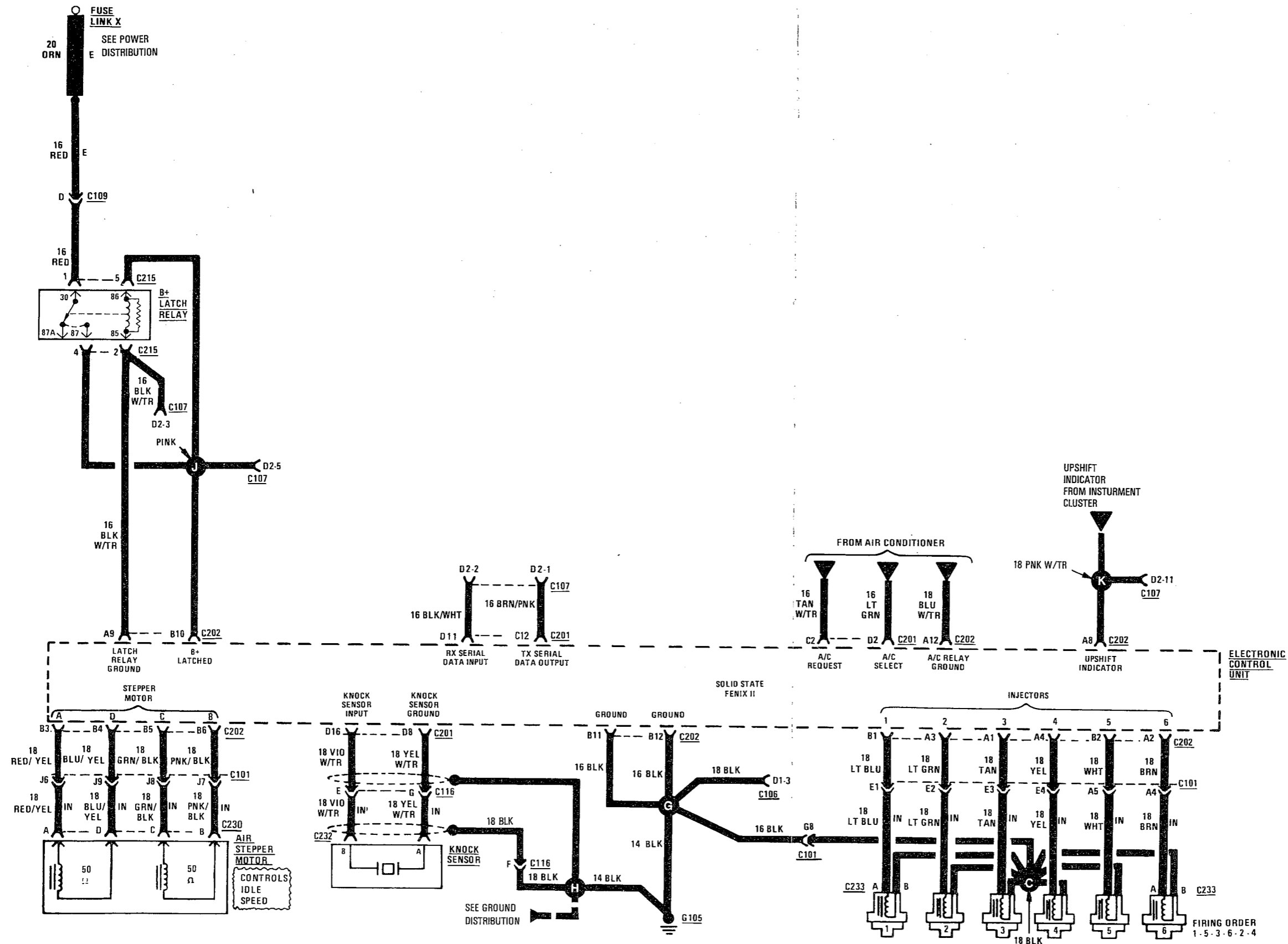

DIAGNOSTIC/CONNECTORS

DIAGNOSTIC CONNECTOR — D1

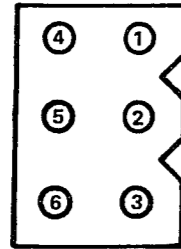

2.5L ENGINE—D1

CAVITY	WIRE COLOR	COMPONENT CONNECTED
1	GRN W/TR	TACHOMETER
2	YEL	IGNITION SWITCH
3	BLK	ECU GROUND
4	GRN W/TR	STARTER SOLENOID
5	RED	BATTERY
6	ORN	FUEL PUMP RELAY

4L ENGINE—D1

CAVITY	WIRE COLOR	COMPONENT CONNECTED
1	GRN W/TR	TACHOMETER
2		NOT USED
3	BLK	ECU GROUND
4		NOT USED
5	RED	BATTERY
6	ORN	FUEL PUMP RELAY

DIAGNOSTIC CONNECTOR — D2

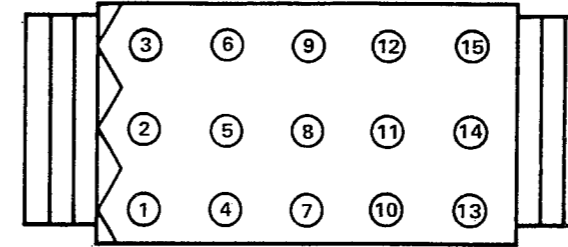

2.5L ENGINE D-2

CAVITY	WIRE COLOR	COMPONENT CONNECTED
1	PNK W/TR	UPSHIFT LAMP (MANUAL) ECU SERIAL DATA (AUTO)
2	BLK W/TR	B + LATCH RELAY (COIL GROUND)
3	BLK W/TR	PARK/NEUTRAL (AUTO) ECU SERIAL DATA (MANUAL)
4	PNK	B + LATCH RELAY (COIL FEED)
5	ORN	A/C CLUTCH RELAY
6	BLU/ORN	POWER STEERING PRES. SW
7	BLK	SYSTEM GROUND
8	TAN W/TR	AIR TEMPERATURE SENSOR
9	ORN W/TR	IGNITION CONTROL MODULE (TIMING)
10	GRN	EGR CANISTER PURGE SOLENOID
11	LT GRN	IDLE SPEED MOTOR (EXTEND)
12	TAN	COOLANT TEMPERATURE SENSOR
13	GRY W/TR	IDLE SPEED CONTROL MOTOR (CLOSED THROTTLE SWITCH)
14	GRN	IDLE SPEED MOTOR (RETRACT)
15	YEL W/TR	AUTO TRANS DIAGNOSIS

4L ENGINE—D2

CAVITY	WIRE COLOR	COMPONENT CONNECTED
1	BRN/PNK	ECU (TX SERIAL DATA OUTPUT)
2	BLK/WHT	ECU (RX SERIAL DATA INPUT)
3	BLK	B + LATCH RELAY (COIL GROUND)
4	YEL	IGNITION SWITCH
5	PNK	B + LATCH RELAY (COIL FEED)
6	ORN/BRN	A/C CLUTCH RELAY
7	BLK	IGNITION CONTROL MODULE GROUND
8	BRN W/TR	MAP SENSOR GROUND
9	ORN	OXYGEN HEATER RELAY
10		NOT USED
11	PNK W/TR	UPSHIFT LAMP (MANUAL TRANS)
12		NOT USED
13		NOT USED
14		NOT USED
15	YEL W/TR	AUTO TRANS DIAGNOSIS

4 SPEED TRANSMISSION CONTROLS — 2.5L

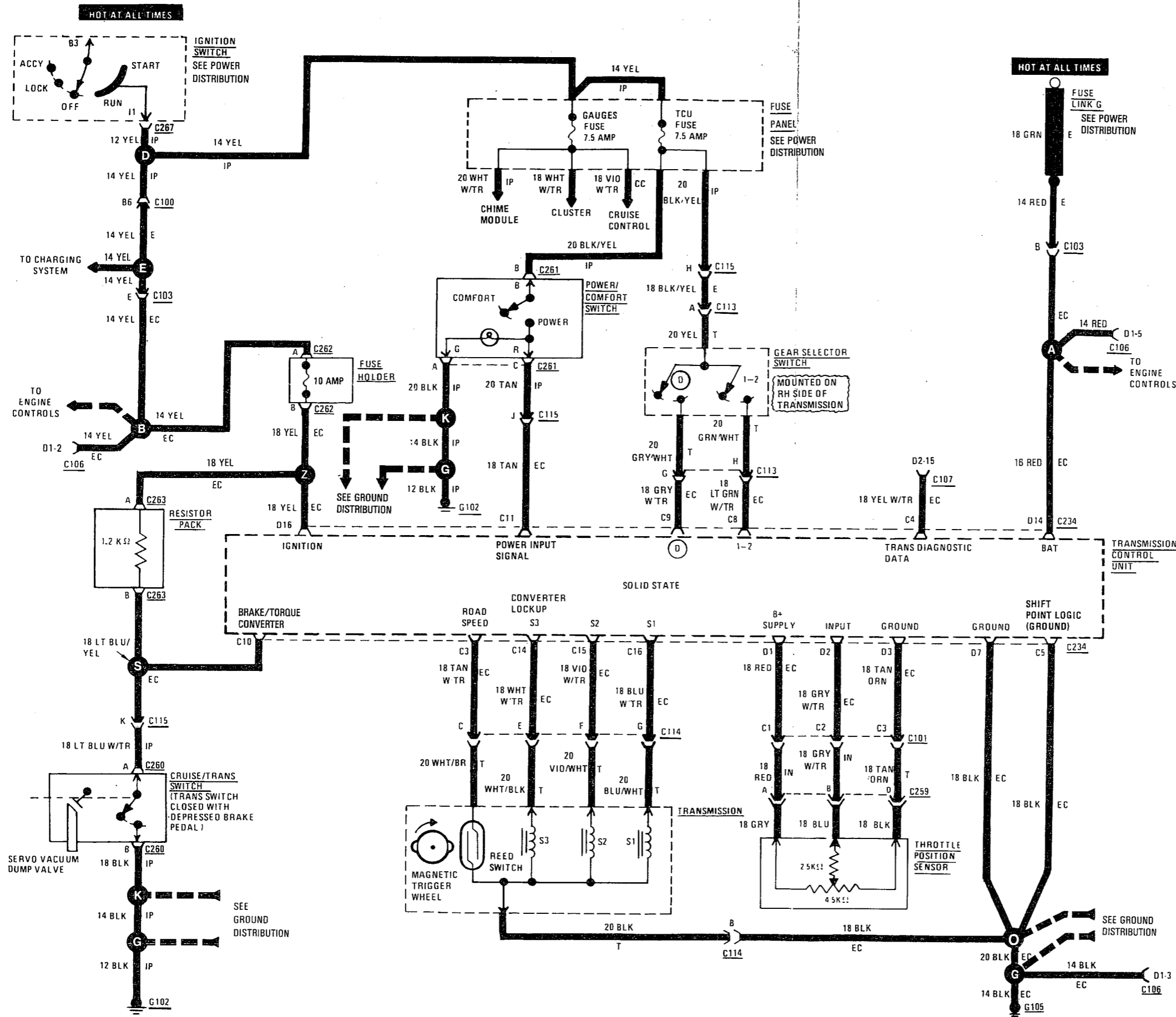

NOTE: FOR DIAGNOSTIC PROCEDURES REFER TO MS 1700 AND TRANSMISSION MANUAL

GEAR	S1	S2
1ST	ON	OFF
2ND	ON	ON
3RD	OFF	ON
4TH	OFF	OFF

4 SPEED TRANSMISSION CONTROLS — 4L

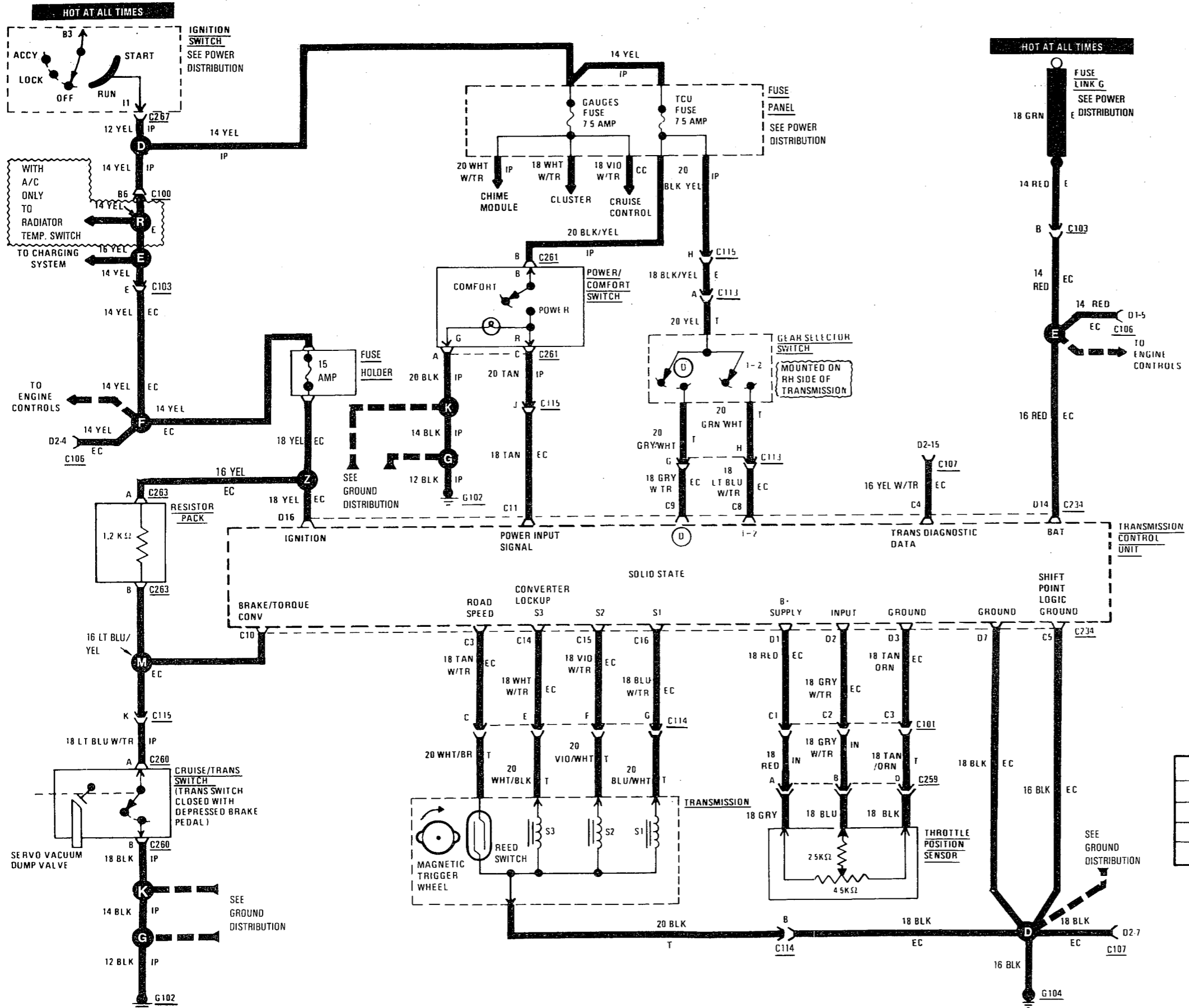

NOTE: FOR DIAGNOSTIC PROCEDURES REFER TO MS 1700 AND TRANSMISSION MANUAL

GEAR	S1	S2
1ST	ON	OFF
2ND	ON	ON
3RD	OFF	ON
4TH	OFF	OFF

2.5L

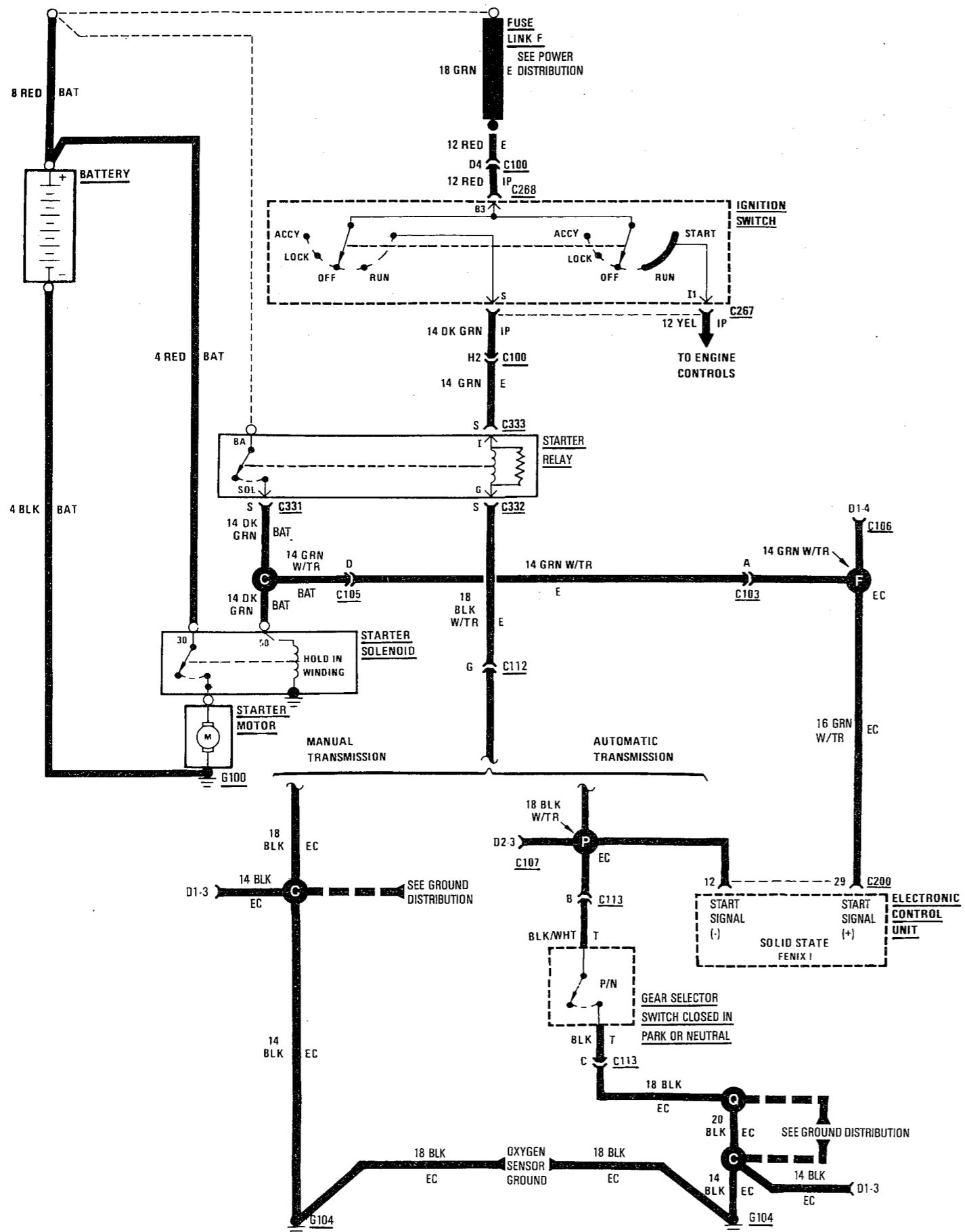

STARTER

4L

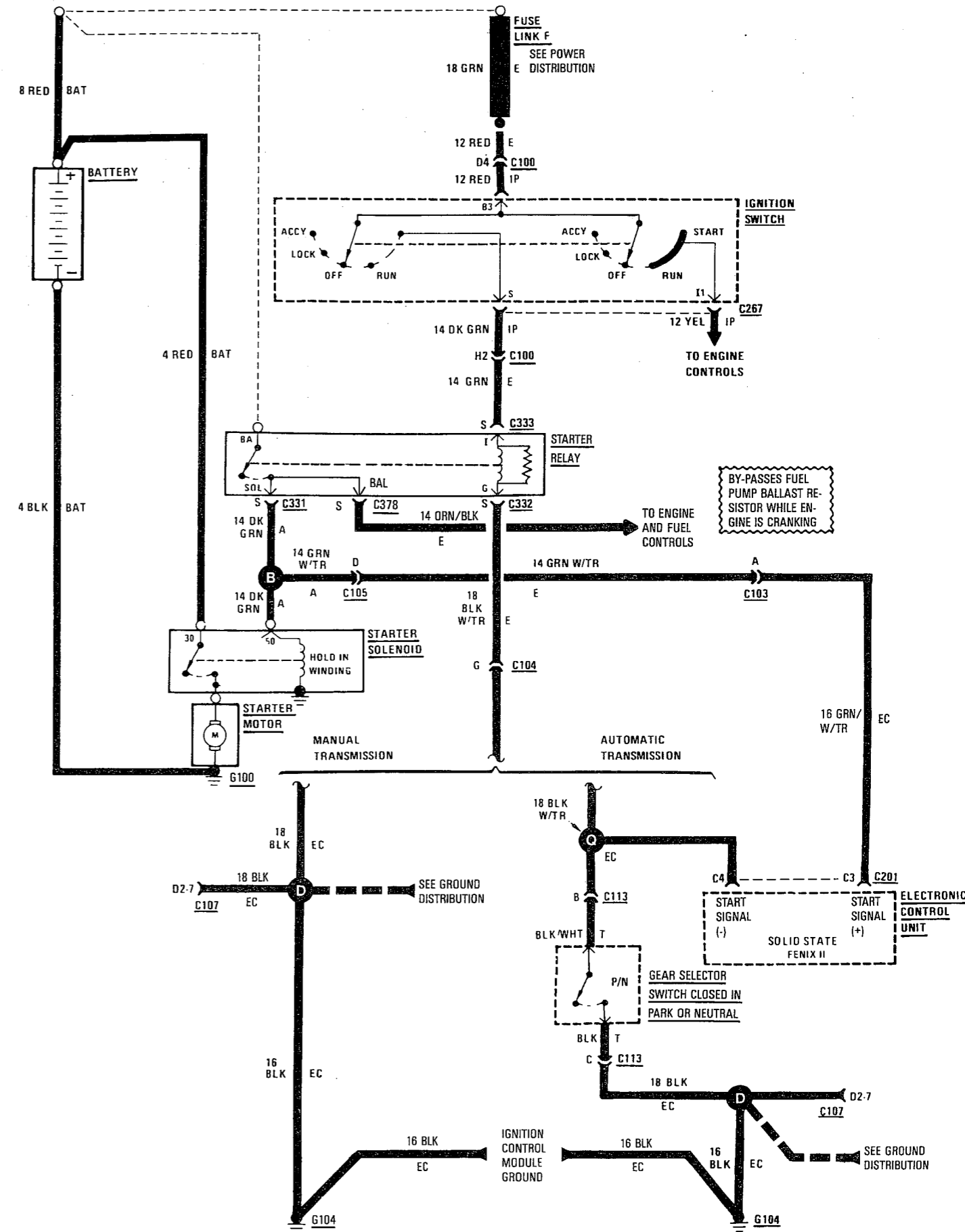

STARTER

DESCRIPTION

The positive battery cable bolts directly to the starter solenoid contact 30. When the ignition switch energizes the starter relay battery power will pass through the relay contacts to terminal 50 of the starter solenoid. Momentary high current through the starter solenoid will connect terminal 30 to the starter motor windings.

The starter relay will not energize until voltage at terminal I and ground at terminal G (G-104) conditions are met.

There are no field windings in the starter motor offered, instead six permanent magnets are used to provide excitation.

Complete starter motor service is outlined in M.R.s'.

TROUBLESHOOTING

1. BATTERY

TEST	OK	NOT OK
Battery	Passed load test	Refer to battery testing
Battery cables	Passes voltage drop test	Refer to voltage drop test

2. STARTER RELAY

Parking Brake fully engaged, Manual Trans in NEUTRAL, Auto Trans in PARK

TEST	OK	NOT OK
Ignition in START	Relay clicks	Next step
Jumper G terminal of relay to ground*	Relay clicks If OK, repair open to G104	Replace relay
Starter Solenoid terminal 50, disconnected**	Battery voltage If OK, replace/rebuild starter	Repair open to relay terminal SOL

* Ignition in Start

** Prevent terminal from touching metal parts

3. STARTER MOTOR

Parking Brake Fully Engaged, Manual Transmission in NEUTRAL, Automatic Transmission in PARK. Remove crank as outlined, ignition switch OFF.

TEST	OK	NOT OK
Cold cranking test as outlined	Passes specifications	Replace/rebuild starter motor as outlined in M.R.s'

TESTING

BATTERY TESTING

General

NOTE: A complete battery test includes:

- Cleaning the top of the battery case.
- Cleaning the battery posts and cable terminals.
- Performing Hydrometer and Battery Load Tests.

The condition of a battery may be determined from the results of two tests.

1. Hydrometer Test (state of charge)
2. Battery Load Test (ability to supply current)

Perform the Hydrometer Test first. If the specific gravity is less than 1.225, the battery must be charged before further testing. A battery that will not accept a charge is defective and further testing is not necessary.

A battery that has been fully charged but does not pass the Battery Load Test is defective.

NOTE: A battery with sulfated plates may require an overnight "slow charge" to determine if sulfate coating is thin enough to be eliminated by a "charge".

If a battery discharges and no apparent cause is found, fully charge the battery and allow to stand on a shelf for three to seven days to determine if the self-discharge rate is excessive. The rate is excessive if the battery will not pass a Battery Load Test.

A battery is fully charged when all cells are gassing freely and three corrected specific gravity tests, taken at one-hour intervals, indicate no increase in specific gravity.

Hydrometer Test

Prior to testing, visually inspect the battery for any damage (cracked container or cover, loose post, etc.) that would cause the battery to be unserviceable.

NOTE: Periodically disassemble the hydrometer and wash components with soap and water. Inspect the float for possible leaks. If the paper inside has turned brown, the float is defective.

Keep the hydrometer in a vertical position while drawing electrolyte into the hydrometer and observing specific gravity.

To interpret the hydrometer correctly, hold it with the top surface of the electrolyte in the hydrometer at eye level.

Refer to the illustration below while performing the following procedure. Disregard the curvature of the liquid where the surface rises against the float (A) because of surface cohesion. Remove only enough electrolyte from the battery to keep the float (B) off the bottom of the hydrometer barrel (C) when pressure on the bulb (D) is released.

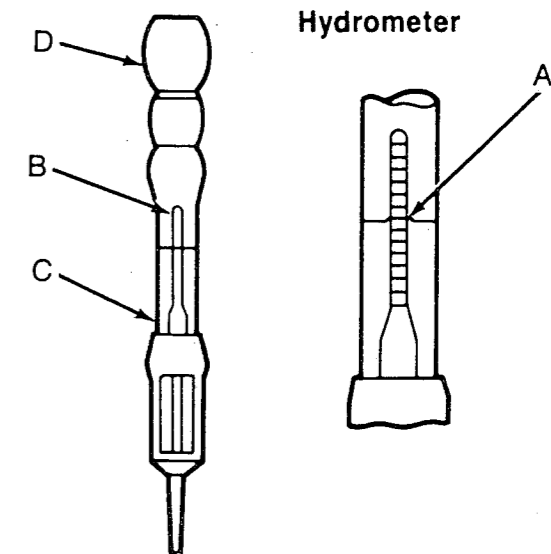

849028

CAUTION: Exercise care when inserting tip of hydrometer into a cell to avoid damaging the separators which may result in premature battery failure.

The specific gravity is a ratio of the density of the electrolyte and the density of pure water. The electrolyte is composed of sulfuric acid and water. Acid comprises approximately 35% by weight or 24% by volume.

Hydrometer floats are generally calibrated to indicate specific gravity correctly at one fixed temperature, 80°F. When testing the specific gravity at any other temperature, a correction factor is required.

The correction factor is approximately a specific gravity value of 0.004, referred to as four points of specific gravity. For each 10°F below 80°F, subtract four points. For each 10°F above 80°F, add four points. Always correct the specific gravity for temperature variation.

Example: A battery is tested at 10°F having a specific gravity of 1.240. Determine the actual specific gravity as follows:

1. Determine the number of degrees above or below 80°F.
 $80^{\circ}\text{F} - 10^{\circ}\text{F} = 70^{\circ}\text{F}$
2. Divide the above result by 10.
 $70^{\circ}\text{F} \div 10 = 7$
3. Multiply the result from Step 2 by the temperature correction factor (0.004).
 $7 \times 0.004 = 0.028$
4. The temperature at testing was below 80°F, therefore the temperature correction is subtracted.
 $1.240 - 0.028 = 1.212$

The corrected specific gravity is 1.212.

The fully charged battery should have a temperature corrected specific gravity of 1.250 to 1.265.

STARTER

Test the specific gravity of the electrolyte in each battery cell.

State of Charge	Specific Gravity	Charge Rate	Charging Time
Fully Charged	1.280		
75% Charged	1.225	20	50 min
50% Charged	1.190	20	70 min
25% Charged	1.155	20	90 min
Discharged	1.120	5	12 hrs

If the specific gravity of all cells is above 1.235, but the variation exists between cells of more than 50 points (0.050), the battery is internally shorted and therefore, unserviceable.

If the specific gravity of one or more cells is less than 1.235, recharge the battery at a rate of approximately 5 amps until three consecutive specific gravity tests, taken at one-hour intervals, are constant.

If the cell specific gravity variation is more than 50 points (0.050) at the end of the charge period, replace the battery.

When the specific gravity of all cells is above 1.235 and variation between cells is less than 50 points (0.050), perform the Battery Load Test.

The following illustration shows the connections necessary to perform the Battery Load Test and the Cold Cranking Test. The procedures for these two tests are for the Volts-Amps Tester S-VAT-40. Refer to the manufacturers instructions if using another meter.

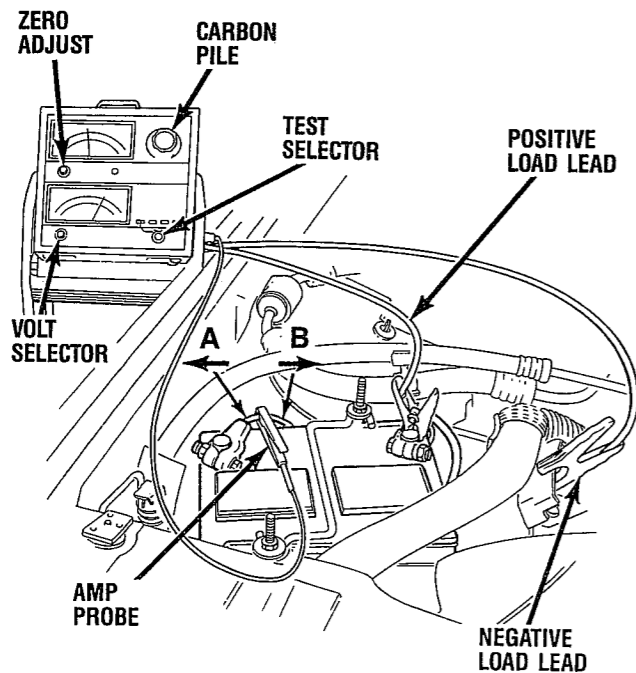

Battery Load Test

NOTE: Before performing the Battery Load Test, the battery must be fully charged.

1. Turn the carbon pile rheostat knob of the battery tester to the OFF position.
2. Turn volt selector knob to EXT 0-18VDC
3. Clamp directly on positive battery post
4. Clamp directly on negative battery post
5. Adjust amperes meter to read "0" by turning zero adjust knob
6. Turn carbon pile until cold cranking amperage appears on ampere meter
7. Hold this figure for 15 seconds. Note volts reading and turn carbon pile to "OFF"
8. If volts reading fell below 9.6 volts, replace battery.

Group Size	Cold Cranking Amperage	Reserve Capacity (in minutes)
US		
58	390	75
58	475	82

If the battery is being replaced under warranty, the battery assembly and shipping date codes must be entered on the warranty claim form. Refer to the following illustration for date code locations.

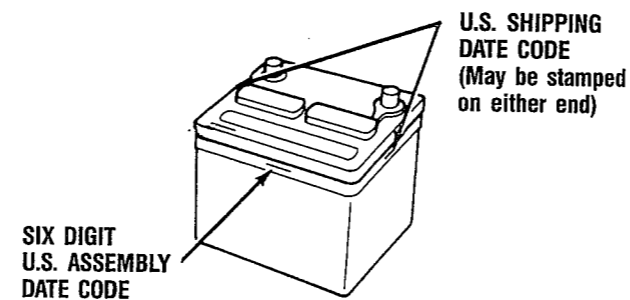

U.S. Date Codes			
Example: N → 1 C → 3 1 → 5 7 → 5	Position 4	A	JAN G JUL
		B	FEB H AUG
Ososso, Wet, March 7, 1985	Position 5	C	MAR I SEP
		D	APR J OCT
		E	MAY K NOV
		F	JUN L DEC
Position 1	N = Ososso Y = Toledo L = Louisville G = Geneva	Position 6	1 through 9 = 1st-9th A through W = 10th-31st Note: 1 is not used
Position 2	Blank		6 = 1986 8 = 1988 7 = 1987 9 = 1989
Position 3	1 = Wet		

Cold Cranking Test

Battery must first pass load and voltage drop tests and be fully charged before proceeding.

1. Turn volt selector knob to EXT 0-18VDC
2. Clamp on positive load lead
3. Clamp on negative load lead
4. Clamp on AMP probe with arrow pointing in direction, (A)
5. Adjust amperes meter reading to "0", by turning zero adjusting knob
6. Fully engage parking brake, place manual transmission in NEUTRAL, automatic transmission in PARK
7. Remove crank engine as shown in the following illustration, using a remote crank switch.

Remote Crank: Unplug (I) connection, place one lead on I, the other on positive battery post.

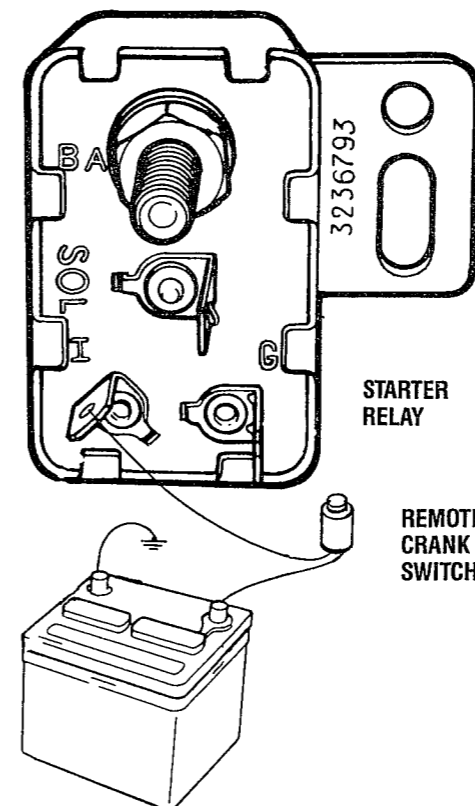

8. Depress remote crank switch. Note cranking voltage and amperage.
9. Replace or rebuild starter motor if specifications are not met. **NOTE:** A cold engine will increase starter motor current.

Cold Cranking Specifications

Battery Test Voltage	Cranking Voltage	Approximate Cranking Current
12-13V	Not less than 9.6V	160 AMPS

Voltage Drop Test

The voltage drop test measures the mechanical condition of any electrical connection. The test is performed under full load (ignition disabled and starter motor cranking). Observe all safety precautions. Remove crank as outlined.

Do not perform checks as illustrated until battery has passed battery load test. If test voltage exceeds .5V, clean metal surface. Apply a thin layer of silicone grease. Install a new cadmium plated bolt and star washer (brass nut on starter solenoid). Retest and replace cable if voltage is not below 0.5 volts.

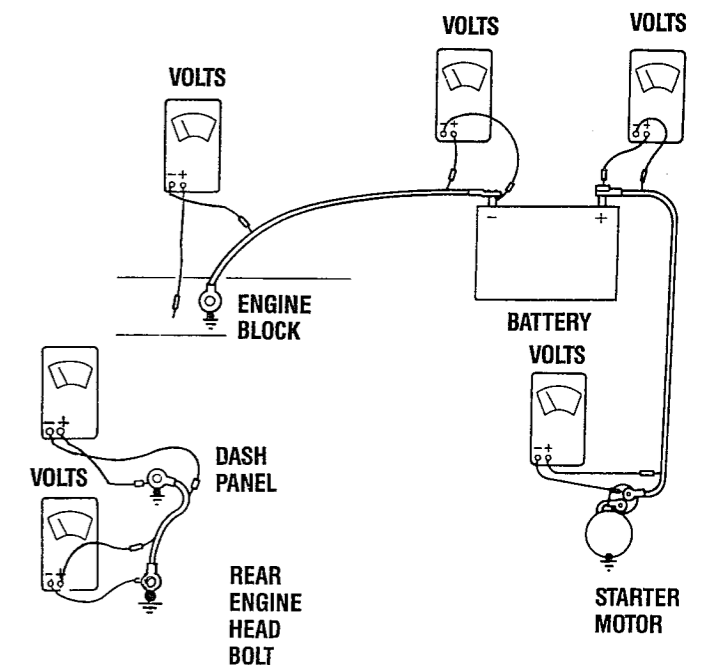

CHARGING SYSTEM

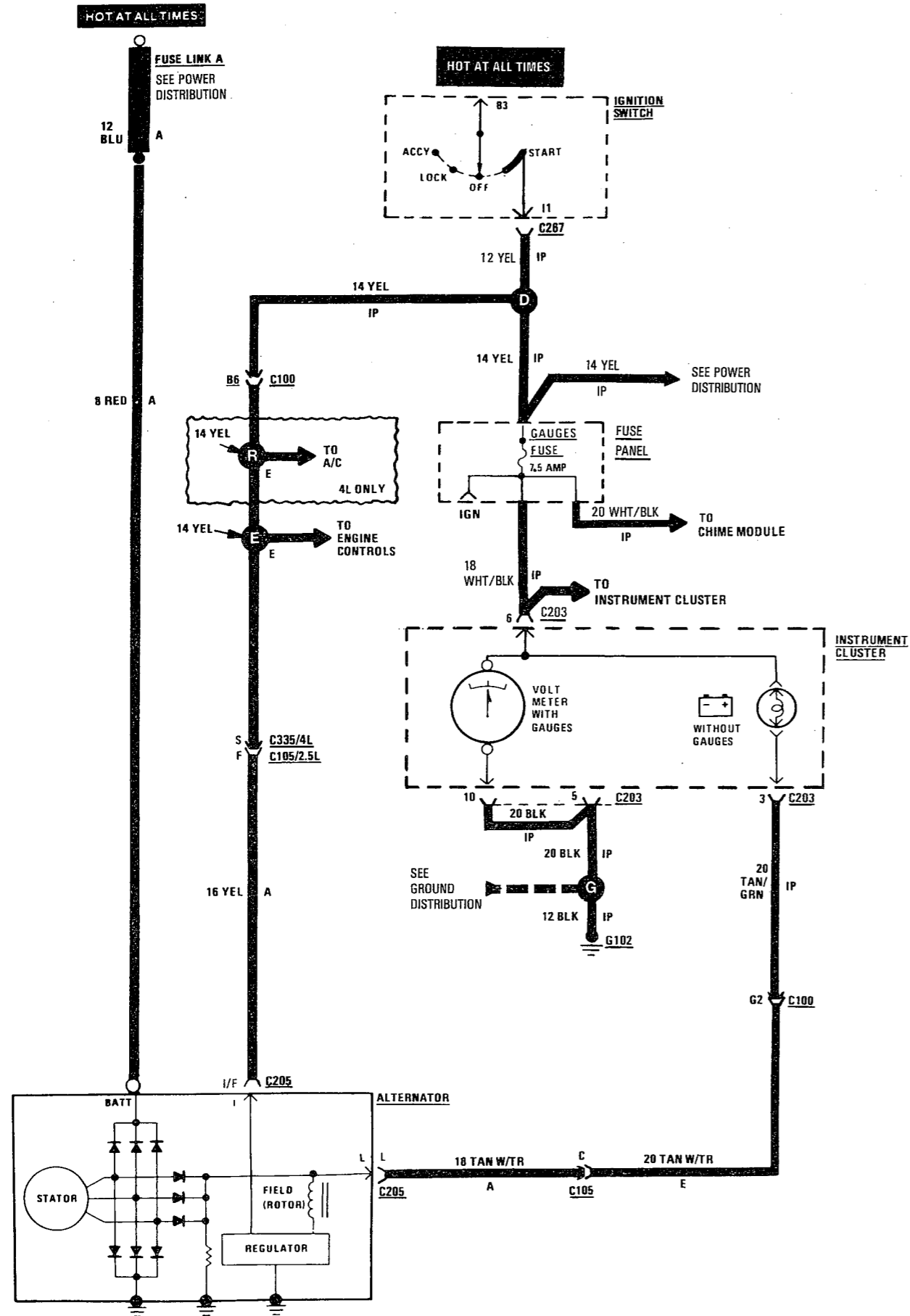

DESCRIPTION

The alternator powers the car's electrical equipment and charges the battery. Alternating current is generated by the stator as the field rotates. The rectifier bridge converts the alternating current to direct current.

The amount of dc voltage produced by the alternator is controlled by the solid state regulator. When battery voltage is

low, the regulator increases the current flowing through the field. This increases the alternator's output voltage to the battery.

One of the features of this regulator is to turn on the battery indicator (if equipped) when the system voltage is too high or too low (with the engine running).

OPERATIONAL CHECK: W/BATTERY INDICATOR

1. The battery indicator comes on when the ignition switch is turned to the RUN or START position. After the engine starts, the charge indicator goes off. With the engine running, the charge indicator should come on only when there is a problem in the charging system.

OPERATIONAL CHECK: W/VOLTMETER

When the ignition switch is turned to the RUN position, battery potential will register on the voltmeter. During engine cranking a lower voltage read will appear on the meter. With the engine running, a voltage reading higher than the first reading (ignition in RUN) should register.

SYMPTOMS

The following symptoms indicate that the charging system may not be operating properly:

General:

- Battery water consumption is excessive, indicating alternator output voltage is over 15 volts. High output reduces bulb life.
- Alternator noise
 - loose mounting bolts
 - loose or misaligned pulley
 - worn slip rings and brushes
 - shorted rectifier diode(s)

With Battery Indicator:

- Battery indicator does not go out after engine starts.
- Battery indicator goes out after start-up, but engine cranking is sluggish.
- Battery indicator goes out after start-up, but engine cranking is extremely fast.

With Voltmeter (gauge):

- A lower or higher than normal reading with engine running.
- If reading is lower than normal with ignition in RUN and all accessories OFF refer to Starting, for battery condition.

CHARGING SYSTEM

TROUBLESHOOTING

1. BATTERY/CABLES/DRIVE BELT

Perform Operational Check Before Troubleshooting

TEST	OK	NOT OK
Inspect condition of battery cable terminals	Clean and tight	Repair as required
Battery state of charge Refer to BATTERY specific gravity and load test procedures Refer to STARTER	Battery passes test	Charge or replace battery as required
Inspect drive belt condition and tension	Drive belt serviceable	Tension or replace belt as required Refer to Belt Tension Specifications
Inspect connection at alternator B+ output	Clean and tight	Repair as required

2. ALTERNATOR CONNECTIONS (WITH BATTERY INDICATOR)

Ignition in RUN; 2.5L unplug C205

4L unplug C105 (refer to Harness Routing Views)

TEST	OK	NOT OK
Jumper TAN W/TR wire to ground	Battery indicator lights	Check bulb If OK, repair open to C203 terminal 3
YEL wire	Battery voltage	Repair open to splice D of I.P. harness
RED wire at BATT terminal	Battery voltage	Remove negative battery cable and replace Fuse Link A

2. ALTERNATOR CONNECTIONS (WITH VOLTMETER (GAUGE))

Ignition in RUN; 2.5L unplug C205

4L unplug C105 (refer to Harness Routing Views)

TEST	OK	NOT OK
YEL wire	Battery voltage	Repair open to splice D of I.P. harness
RED wire at BATT terminal	Battery voltage	Remove Negative Battery Cable and replace Fuse Link A

3. BATTERY DISCHARGE THROUGH ALTERNATOR OR COMPONENTS

TEST	OK	NOT OK
Refer Current Leakage Test	No current leakage	Replace alternator or components for excessive drain

4. ALTERNATOR OUTPUT

TEST	OK	NOT OK
Refer to Alternator Output Test	Output as specified	Replace alternator as outlined in the appropriate M.R.

TESTING

Current Leakage Test

Current leakage refers to power being drained from the battery with the ignition turned off. (Battery drain should not exceed 20 MA (20 milliamps = 0.020 amps), typical draw is 0.10 M.A.

The 20 MA are needed to supply:

- ECU memory
- Digital clock memory
- ETR (electronically tuned radio) memory

Excessive battery drain is caused by:

- Items left turned on
 - reading lamps
 - dome lamps, (door ajar)
 - trunk lamp
- Internally shorted alternator
 - bad diode in rectifier bridge
 - shorted stator windings
 - shorted regulator
- Intermittent short in wiring

Current leakage up to 10 amps can be measured with the analog multimeter 260-7, (8981320941). Use the S-VAT-40 to first determine that current leakage is under 10 amps. Refer to the following illustration for 10 amp testing hookup.

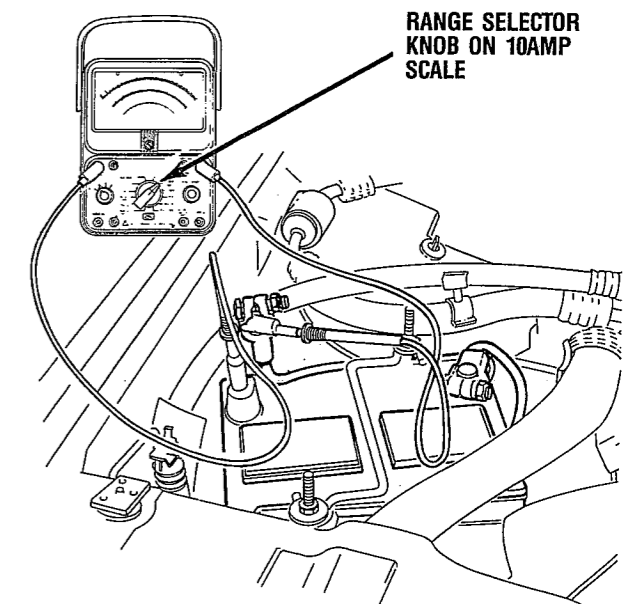

If draw is below 0.1 amp, shut off dome, map and courtesy lamps and go to 100 AM hookup. Failure to shut off dome, map and courtesy lamps will result in excessive current draw and meter damage when a door is opened.

CHARGING SYSTEM

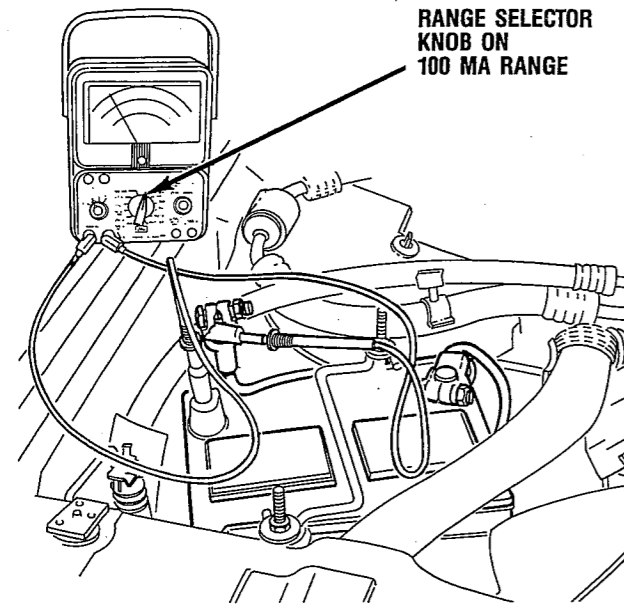

RANGE SELECTOR
KNOB ON
100 MA RANGE

Current leakage can be isolated using the power distribution schematic. Main power branches can be isolated by removing one lead at a time from the Starter Relay. Further isolation can be obtained by removing circuit breakers and fuses. The meter reading drops once the high current problem is found. Repair this section of the circuit, whether it's a wiring short or component failure. High current leakage may lead to an incorrect diagnosis and unnecessary battery replacement.

Alternator Output Test

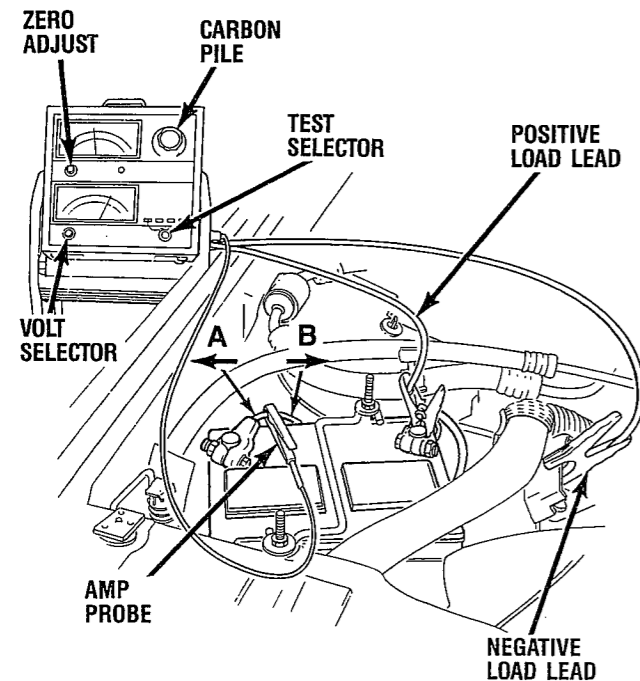

The following instructions refer to the S-VAT-40, volts-amps-tester. Refer to the manufacturer's instructions if using another meter.

NOTE: Battery must first pass load and voltage drop tests. Refer to STARTER.

1. Turn carbon pile knob to OFF.
2. Turn volt selector knob to EXT 0-18 VDC.
3. Clamp on positive load lead.
4. Clamp on negative load lead.
5. Clamp on amp probe with arrow pointing in direction B.
6. Adjust amperes meter reading to "0" by turning zero adjusting knob.
7. Fully engaged parking brake. Place manual transmission in NEUTRAL, automatic in PARK.
8. Start engine.
9. Refer to Output Specifications chart.
 - a. Set engine RPM.
 - b. Turn carbon pile to match alternator output.
 - c. Battery voltage should not drop below 13.5V or go above 15V.
 - d. If alternator output is within 15 amperes of rated output, alternator is acceptable. If not within 15 amperes of rated output, replace the alternator.

NOTE: Regulator cannot be repaired. The alternator is on a remanufacturing program with Delco.

CS-121
OUTPUT SPECIFICATIONS

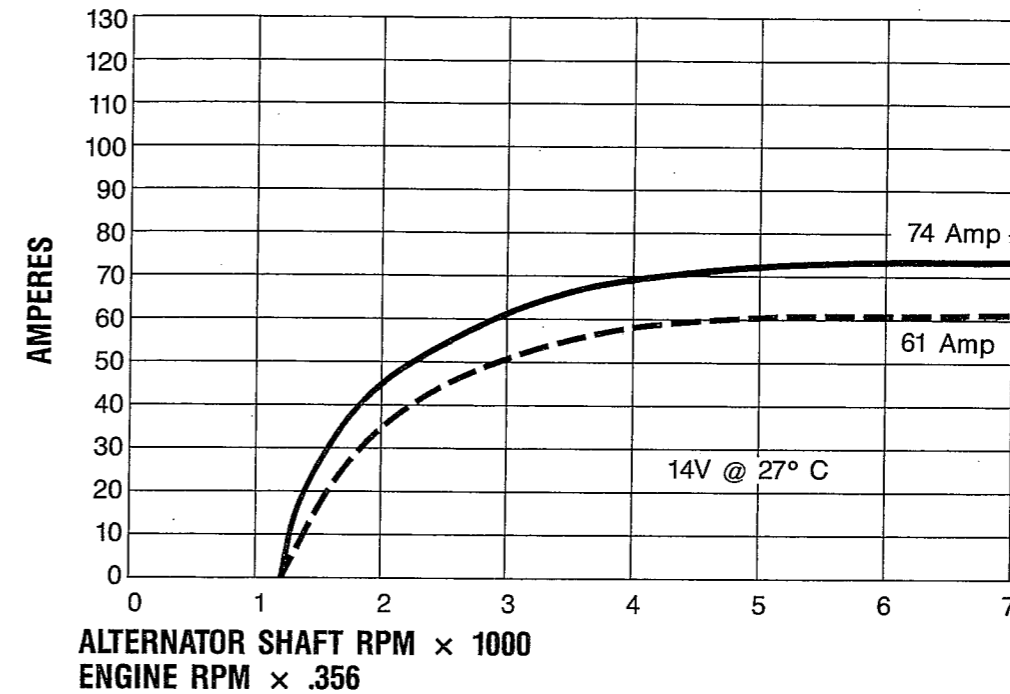

CS-130
OUTPUT SPECIFICATIONS

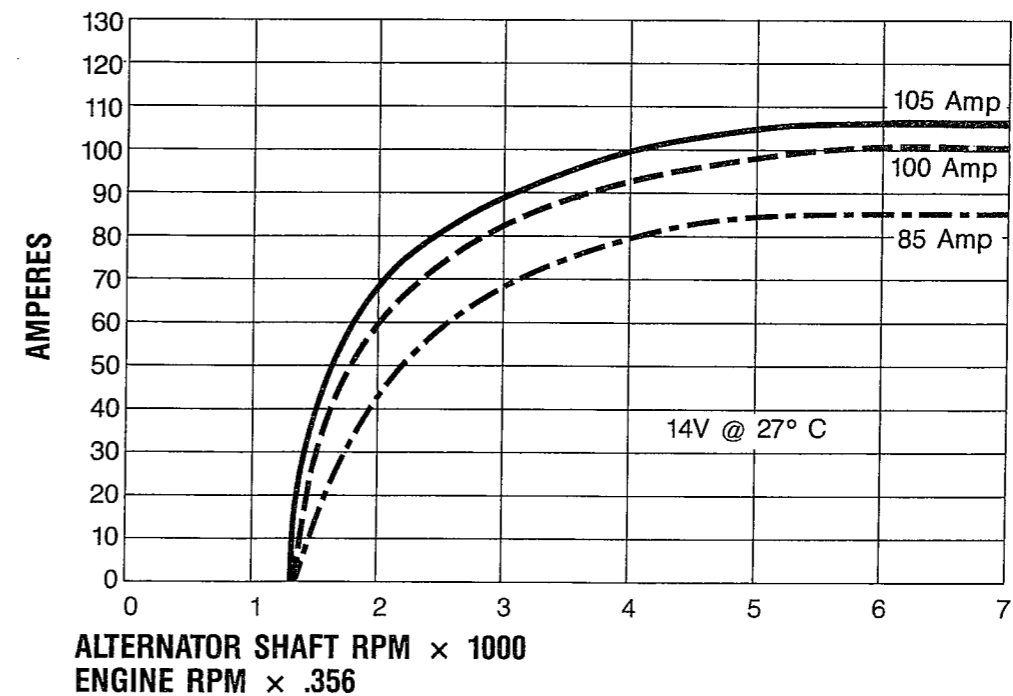

CHARGING SYSTEM

SERPENTINE BELT

2.5L
WITHOUT POWER STEERING

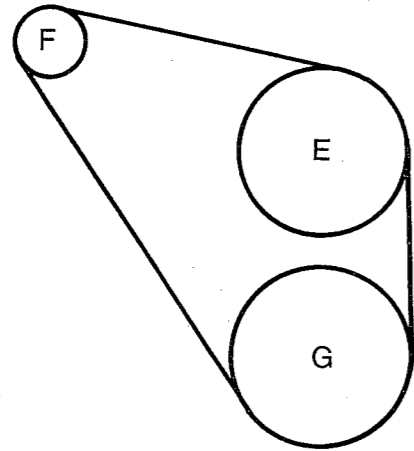

2.5L

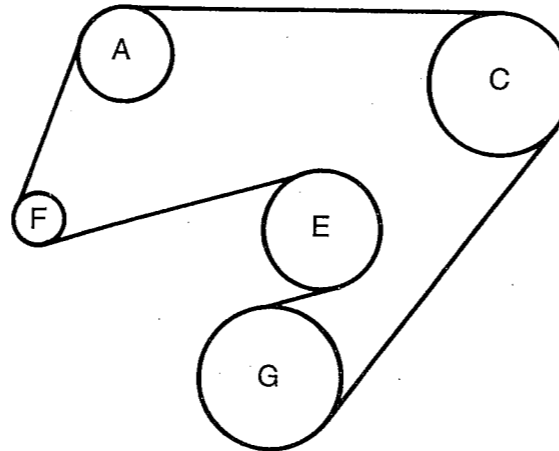

- A - Idler Pulley — Non-A/C
- A - A/C Compressor — Equipped with A/C
- B - Backside Idler Pulley
- C - Power Steering Pulley
- D - Fan Pulley
- E - Water Pump Pulley
- F - Alternator
- G - Vibration Damper

Using Tool J-23600-B	
TENSION	N (lbs-f)
Initial (new belt)	Reset (used belt)
800 - 900 (180-200)	623-712 (140-160)

4L

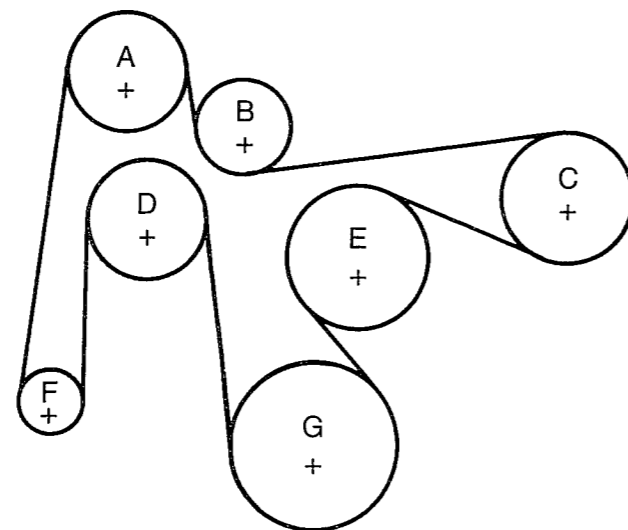

INSTRUMENT CLUSTER/INDICATORS

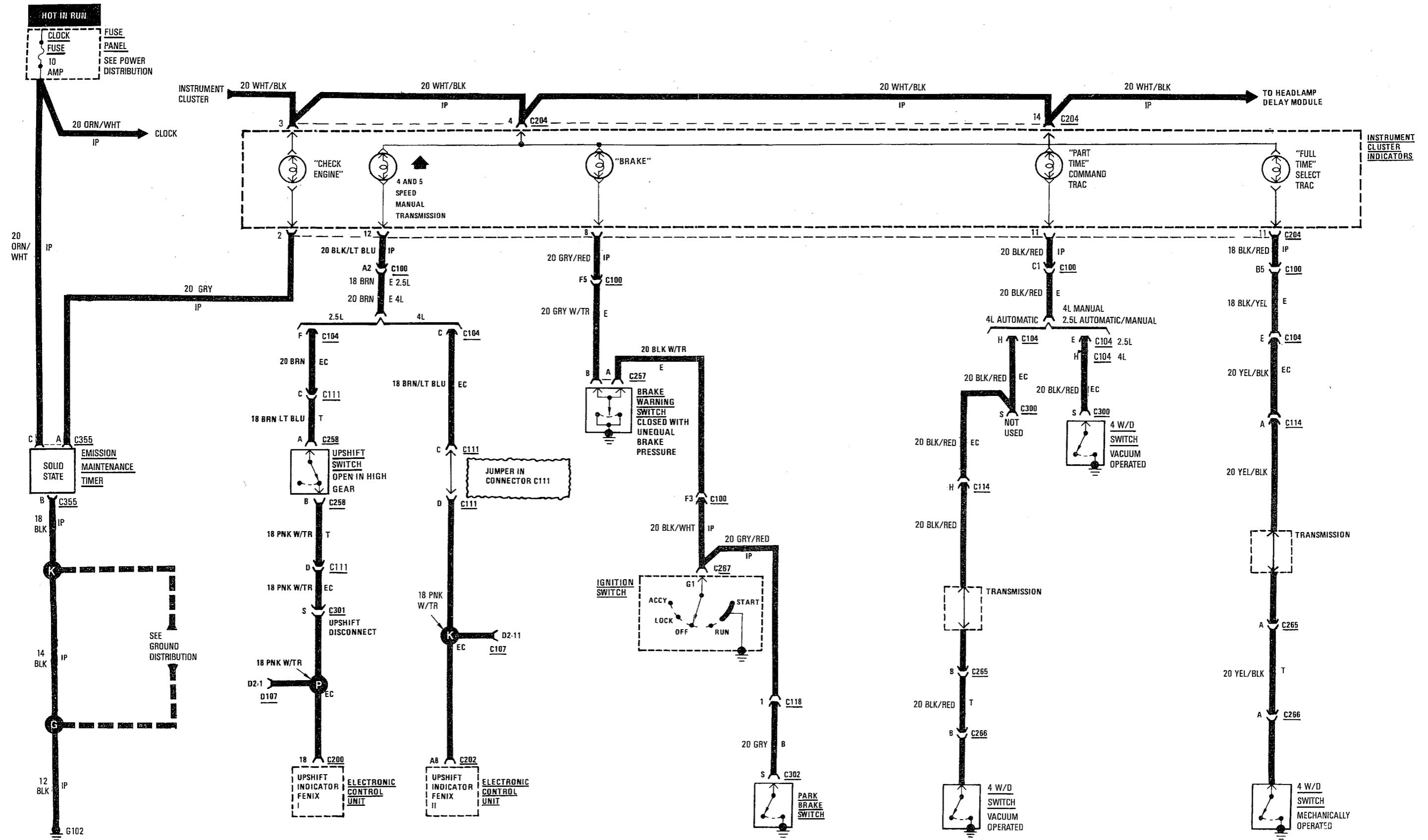

INSTRUMENT CLUSTER

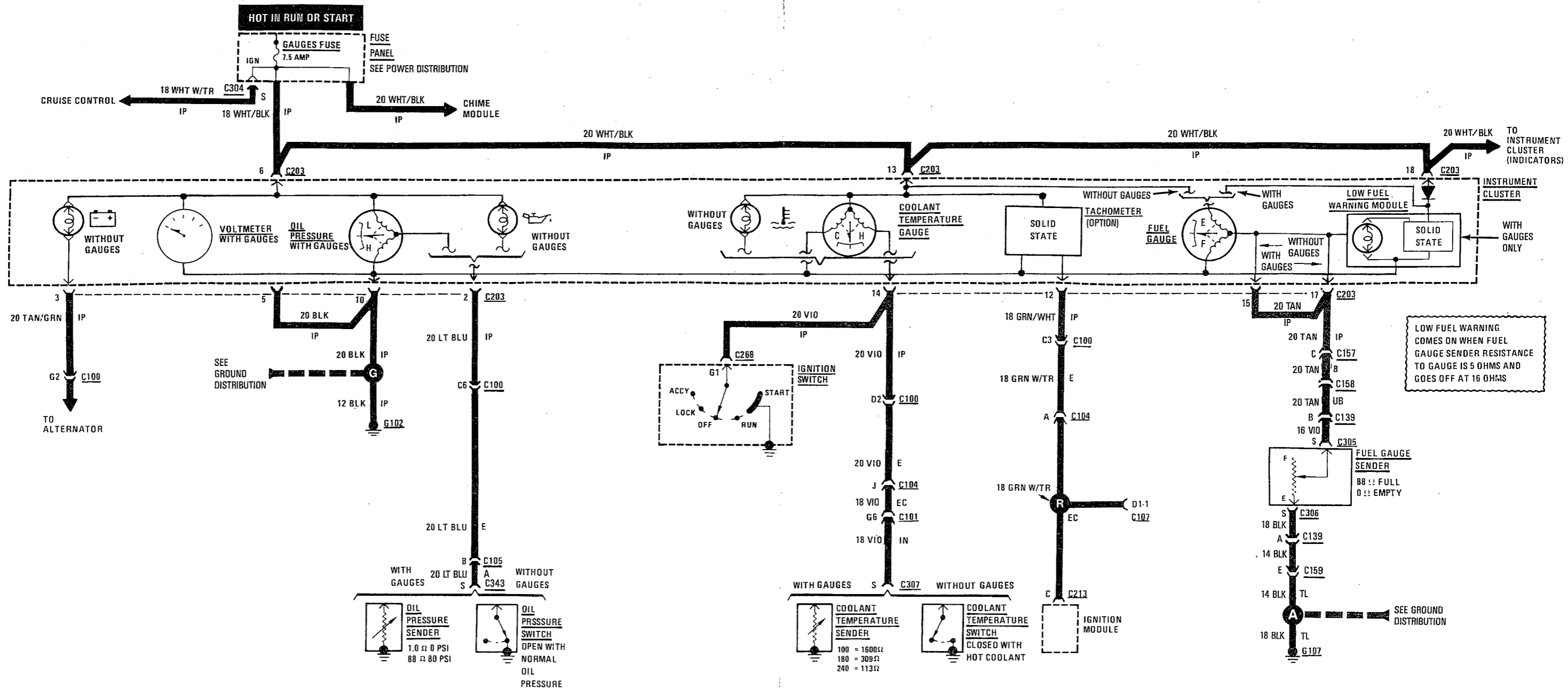

INSTRUMENT CLUSTER

DESCRIPTION — GENERAL

With the ignition switch in the RUN or START position, voltage is applied to the instrument cluster from the gauges

fuse. The voltage applied to the instrument cluster is applied to all the gauges and indicators through the instrument cluster printed circuit.

TROUBLESHOOTING

1. GAUGES AND INDICATORS — INOPERATIVE

Remove and inspect fuse

TEST	OK	NOT OK
Gauges fuse	Not blown	Replace fuse

2. GROUND

Remove Cigar Lighter

TEST	OK	NOT OK
Side of Cigar Lighter to ground	Zero ohms	Repair open to G102
C203 terminal 5*	Zero ohms	Repair open to Splice G

* Remove cluster, refer to Repair Manual M.R. 244

DESCRIPTION — VOLTMETER

With the ignition switch in RUN or START, voltage is applied through the gauges fuse to the voltmeter.

The voltmeter measures the output of the alternator when the engine is running. When the engine is not running the voltmeter measures battery voltage.

TROUBLESHOOTING

3. VOLTMETER — INOPERATIVE

TEST	OK	NOT OK
Ignition in RUN	Voltmeter reads battery voltage	Next step
C203 terminal 6	Battery voltage If OK, replace meter	Repair open to Gauges fuse

CHARGE LIGHT

See Charging System.

DESCRIPTION — OIL PRESSURE GAUGE

Current through the coils of the oil pressure gauge creates two opposing magnetic fields that control the position of the needle. Current flows through the L-coil and divides. One

path goes through the H-coil to ground. The other flows through the oil pressure sender to ground. The oil pressure sender is a variable resistor. It's resistance is 88 ohms when the oil pressure is 80 psi, and 1 ohm when the oil pressure is 0 psi. Current through the coils varies as the resistance changes, varying the strength of the magnetic fields.

TROUBLESHOOTING

3. OIL PRESSURE GAUGE — INOPERATIVE

Ignition in RUN

TEST	OK	NOT OK
Disconnect C343 terminal S	Needle goes to H	Next step
Touch C343 terminal S to ground	Needle goes to L If OK, replace sender	Repair open to gauge

DESCRIPTION — OIL PRESSURE INDICATOR

The oil pressure indicator lights when the oil pressure is too low. With the ignition switch in RUN or START, voltage

is applied through the gauges fuse and the indicator bulb to the oil pressure switch. The switch closes and provides a path to ground when oil pressure is too low.

TROUBLESHOOTING

3. OIL PRESSURE INDICATOR — INOPERATIVE

Ignition in RUN

TEST	OK	NOT OK
Touch C343 terminal S to ground	Lamp lights If OK, replace switch	If bulb is OK, repair open to C203 terminal 2

INSTRUMENT CLUSTER

DESCRIPTION — COOLANT TEMPERATURE GAUGE

Current through the coils of the coolant temperature gauge creates two opposing magnetic fields that control the position of the needle. Current flows through each coil. One path goes through the C- coil to ground. The other flows through

the H- coil and the coolant temperature sender to ground. The coolant temperature sender is a variable resistor. It has a low resistance when the coolant is hot and a high resistance when the coolant is cool. Current through the coils varies as the resistance changes, varying the magnetic fields that control the needle position.

TROUBLESHOOTING

3. COOLANT TEMPERATURE GAUGE — INOPERATIVE

Ignition in RUN

TEST	OK	NOT OK
Disconnect C307 terminal S	Needle goes to C	Next step
Touch C307 terminal S	Needle goes to H If OK, replace sender	Repair open to gauge

DESCRIPTION — COOLANT TEMPERATURE INDICATOR

The Coolant Temperature Indicator lights when the engine coolant temperature is too high. With the Ignition Switch in

RUN or START, voltage is applied through the GAUGES fuse and the Indicator bulb to the Coolant Temperature switch. The switch closes and provides a path to ground when engine coolant temperature is too high.

3. COOLANT TEMPERATURE INDICATOR — INOPERATIVE

TEST	OK	NOT OK
Touch C307 terminal S to ground	Lamp lights If OK, replace switch	If bulb is OK, repair open to C203 terminal 14

DESCRIPTION — TACHOMETER

The tachometer displays the engine speed, (RPM).

With the ignition switch in RUN or START voltage is applied through the gauges fuse to the solid state tachometer. With the engine running, the tachometer receives an engine speed signal from the negative side of the ignition coil.

TROUBLESHOOTING

3. TACHOMETER — INOPERATIVE

Engine RUNNING

TEST	OK	NOT OK
Ignition coil C213 terminal C or diagnostic connector DI-1	AC voltage	Replace ignition coil
Instrument cluster connector C203 — terminal I2	AC voltage	Repair open between ignition coil and instrument cluster
Inspect instrument cluster printed for cracks or poor connections	Replace tachometer	Replace printed circuit

DESCRIPTION — FUEL GAUGE

Current through the coils of the fuel gauge creates two opposing magnetic fields that control the position of the needle. Current flows through the F-coil and divides. One path goes through the E-coil to ground. The other flows through the

fuel gauge sender to ground. The fuel gauge sender is a variable resistor. It's resistance is 88 ohms when the tank is full and 0 ohms when the tank is empty. Current through the coils varies as the resistance changes, varying the strength of the magnetic fields.

TROUBLESHOOTING

3. FUEL GAUGE — INOPERATIVE

Ignition in RUN

TEST	OK	NOT OK
Disconnect C139	Needle goes to F If ground to G107 is OK, replace sender	Next step
C203 terminal 15*	0-88 ohms If OK, replace gauge	Repair open to sender

* Connect C139

INSTRUMENT CLUSTER

DESCRIPTION — LOW FUEL WARNING

The low fuel warning indicator glows when the gas tank holds less than approximately two gallons. With the ignition switch in RUN or START, voltage is applied through the gauges fuse to the solid state low fuel warning module. When

the module senses less than 5 ohms from the fuel gauge sender, it provides a path to ground from the bulb. The module will not open the path to ground from the bulb until the fuel gauge sender resistance is 16 ohms or more.

TROUBLESHOOTING

3. LOW FUEL WARNING — INOPERATIVE

Ignition in RUN

TEST	OK	NOT OK
Disconnect C139	Lamp (LED) lights If OK, replace sender	Replace module

DESCRIPTION

The Emission Maintenance Timer keeps track of Ignition ON time. when 2750 hrs. of driving time has passed the timer

will ground the Check Engine indicator. The timer receives power from the Clock Fuse and grounds through G102.

Refer to the Owners Manual for further information.

DESCRIPTION — UPSHIFT INDICATOR (4 & 5 SPEED MANUAL TRANSMISSIONS)

The upshift indicator lights when the engine speed is high enough to be shifted into a higher gear.

With the ignition switch in RUN or START, voltage is applied through the gauges fuse and the indicator bulb to the

upshift switch. The electronic control unit (ECU) measures manifold vacuum and engine speed. The ECU uses these two values to determine when to provide a ground for the indicator. The 2.5L upshift switch turns the indicator off by removing the ground path when the transmission is in high gear.

TROUBLESHOOTING

3. UPSHIFT INDICATOR — INOPERATIVE

Ignition in RUN, Parking Brake ON, Transmission in first gear

	TEST	OK	NOT OK
2.5L	Jumper D2-1 to ground	Lamp lights If OK, test ECU	Next step
2.5L	Jumper C258 terminal A to ground	Lamp lights If switch is OK, repair open to ECU	If bulb is OK, repair open to indicator
4L	Jumper D2-11 to ground	Lamp lights If OK, test ECU	If bulb is OK, repair open to indicator

DESCRIPTION — BRAKE INDICATOR

The brake indicator warns the driver that the parking brake is on or that the pressure in the brake system is unequal.

With the ignition switch in RUN or START, voltage is applied through the gauges fuse and the brake indicator bulb to three switches. A path to ground for the current is available if:

1. The brake warning switch is closed (with unequal brake system pressures), or
2. The ignition switch is in "start" (to test the bulb), or
3. The park brake switch is closed (with the park brake on).

TROUBLESHOOTING

3. BRAKE INDICATOR — INOPERATIVE

Ignition in RUN, Parking Brake ON, C257 unplugged

	TEST	OK	NOT OK
	Jumper C257 terminal B to ground	Lamp lights	If bulb is OK, repair open to indicator
	C257 terminal A	Zero ohms If OK, check switch and/or brake system	Repair open to Park Brake Switch ground

DESCRIPTION — 4WD INDICATOR

The 4-wheel drive indicator lights when the vehicle is in 4-wheel drive. With the ignition switch in RUN or START, voltage is applied through the gauges fuse and the 4wd indicator and 4wd lock indicator to the command trac switch or the select trac switch. The switch provides a path to ground when the vehicle is in 4-wheel drive.

TROUBLESHOOTING

1. 4WD LOCK OR 4WD INDICATOR — INOPERATIVE

Parking Brake ON, Engine RUNNING, vehicle in 4WD Lock or 4WD

TEST	OK	NOT OK
Unplug switch and touch harness side of wire to ground	Lamp lights If OK, check switch operation, replace if bad	If bulb is OK, repair open to indicator

BLOWER CONTROLS

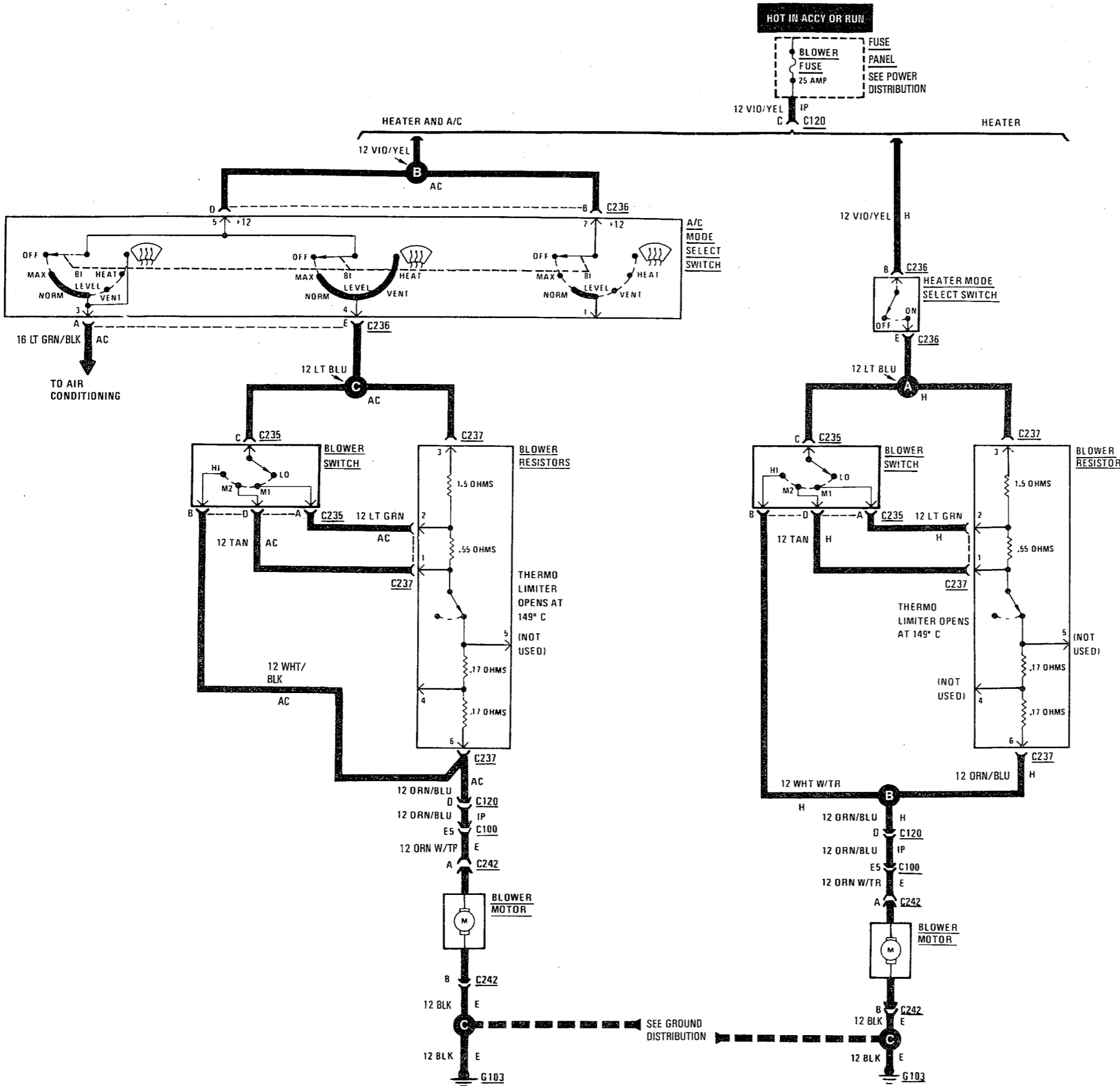

BLOWER CONTROLS

DESCRIPTION

The blower motor delivers air to the inside of the vehicle. Its speed is controlled by the blower switch and the blower resistors. With the switch in "Lo," part of the battery voltage is supplied to the motor through all of the resistors. The motor runs slowly. As the blower switch is moved to select a higher

speed, the switch allows more voltage to be applied to the blower motor, which will increase its speed. When the blower switch is in "Hi," the blower resistors are bypassed. Battery voltage is applied directly to the blower motor. The motor runs at the fastest speed.

TROUBLESHOOTING

1. BLOWER MOTOR INOPERATIVE

Remove and inspect fuse

TEST	OK	NOT OK
Blower fuse	Not blown	Replace fuse

1. BLOWER MOTOR INOPERATIVE IN HI

Ignition switch in RUN, select switch in HEAT, blower switch on HI

TEST	OK	NOT OK
C242 terminal A	Battery voltage	Next step
C242 terminal B*	Zero ohms	Repair wire to ground G103
C235 terminal C	Battery voltage If OK, replace blower switch	Replace select switch

* Ignition switch OFF.

1. BLOWER MOTOR INOPERATIVE IN LO, M1 AND M2

Ignition switch in RUN, select switch in HEAT

TEST	OK	NOT OK
C237 terminal 3	Battery voltage	Replace select switch
C237 terminal 2	Battery voltage	Replace blower switch
C237 terminal 1	Battery voltage	Replace blower switch
C237 terminal 6	Battery voltage	Replace blower resistor

AIR CONDITIONING — 2.5L

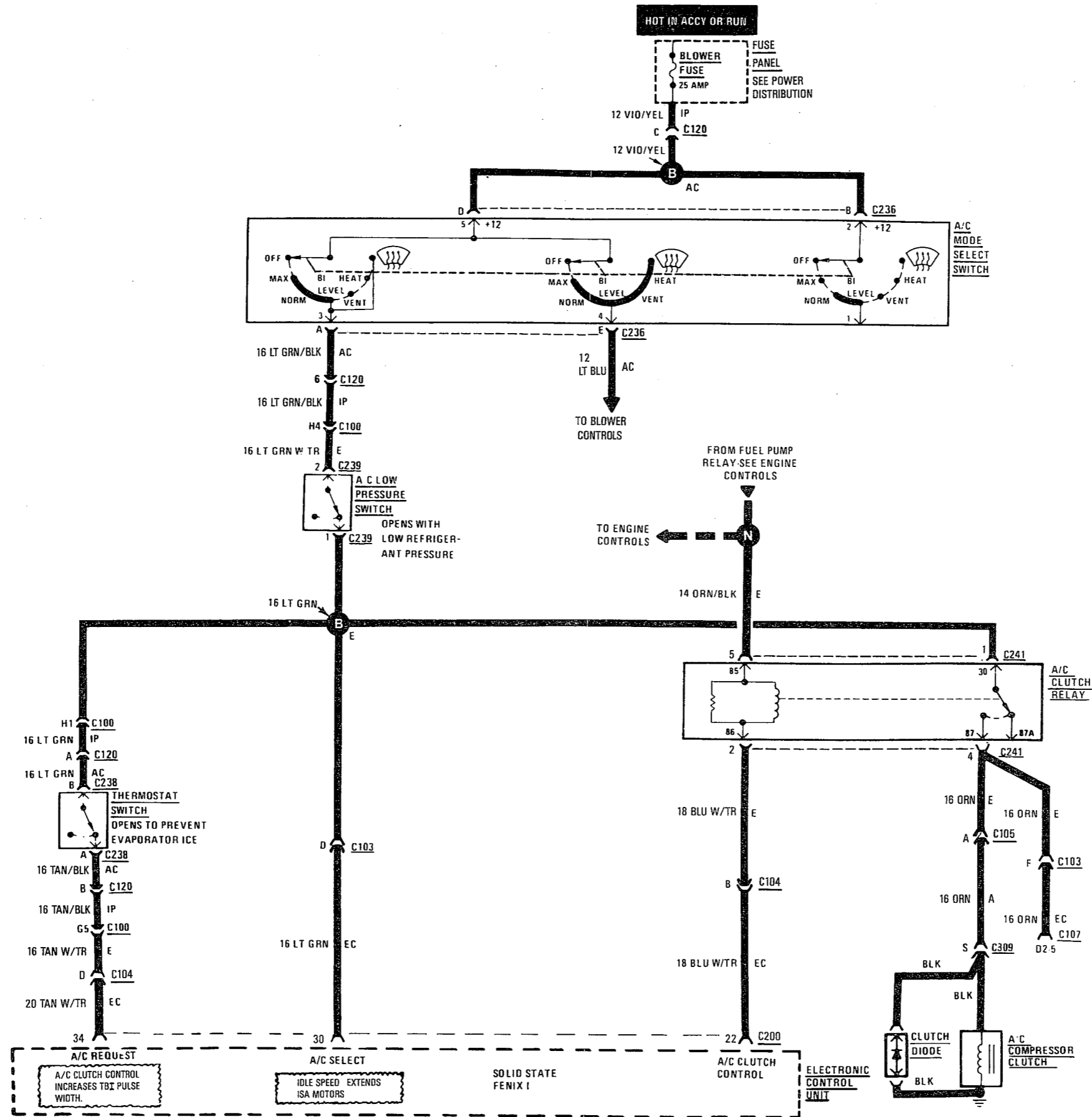

AIR CONDITIONING ENGINE COOLING WITH A/C — 4L

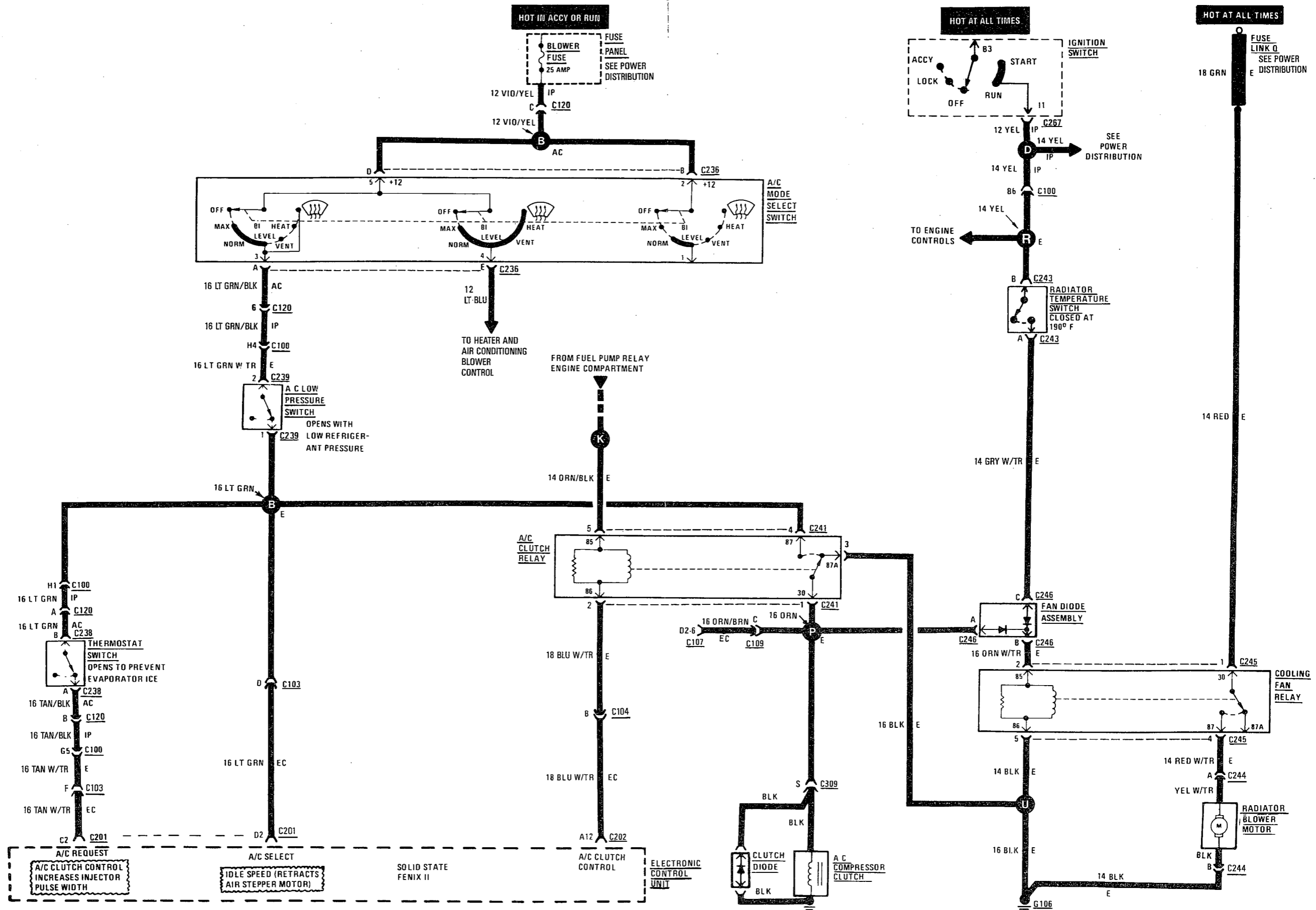

AIR CONDITIONING

DESCRIPTION

The A/C Compressor Clutch is belt-driven by the engine. A clutch, operated by a solenoid, automatically turns the compressor on and off to control evaporator icing.

The A/C Compressor Clutch operation is controlled by several components: the A/C Low-Pressure Switch, Thermostat Switch, Fuel Pump Relay, A/C Clutch Relay, and the Electronic Control Unit (ECU).

The a/c low pressure switch opens when there is not enough refrigerant in the system. When this happens, voltage is no

longer present at the ECU. The ECU will turn off the a/c clutch relay. With the proper refrigerant level in the system, the low pressure switch remains closed.

When the evaporator temperature is low enough to ice the cooling coils, the thermostat switch opens. The ECU will turn off the a/c clutch. The thermostat switch closes when the temperature rises. The ECU will then turn the a/c clutch relay on again.

4. A/C CLUTCH RELAY

Engine RUNNING, a/c controls in MAX or NORM

TEST	OK	NOT OK
D1-6 to ground*	Battery voltage	Check fuel pump relay Check ECU terminals, 2.5L-6/4L-A5
Ground C241 terminal 2	A/C compressor clutch engages	Check ECU terminals, 2.5L 22, 30 and 34/ 4L-A12, C2 and D2

* Refer to engine and fuel controls — diagnostic connectors.

TROUBLESHOOTING

NOTE: With engine running ECU may delay a/c clutch up to 30 seconds

1. A/C COMPRESSOR CLUTCH INOPERATIVE

C309 terminal S disconnected

TEST	OK	NOT OK
Jumper fused test lead, battery to C309 terminal S	Clutch operates	Replace compressor assembly clutch as outlined in MR 244

2. A/C LOW PRESSURE SWITCH

Ignition in RUN, a/c controls in MAX or NORM

TEST	OK	NOT OK
C239 terminal 2	Battery voltage	Repair open to select switch
C239 terminal 1	Battery voltage	Check switch resistance Check freon pressure, refer to MR 244

3. THERMOSTAT SWITCH

Ignition in RUN, a/c controls in MAX or NORM

TEST	OK	NOT OK
C238 terminal B	Battery voltage	Repair open to splice B
C238 terminal A	Battery voltage	Check thermostat switch resistance Check for evaporator icing; no icing, replace switch

ENGINE COOLING WITH A/C-4L

DESCRIPTION

The radiator blower motor operates through the cooling fan relay. The relay is energized by the radiator temperature switch and the a/c clutch relay. The closing of either switch provides battery voltage to the motor from fuse link Q.

The engine cooling package is standard equipment with air conditioning and is required due to the additional condenser heat.

TROUBLESHOOTING

1. RADIATOR BLOWER MOTOR

Cooling fan relay removed

TEST	OK	NOT OK
Jumper fused test lead, battery to C245 terminal 4	Motor runs	Check ground G106 If ground is good replace motor

2. COOLING FAN RELAY

Cooling fan relay removed, ignition in RUN

TEST	OK	NOT OK
C245 terminal 5	Zero ohms	Repair open to ground G106
Jumper fused test lead, C245 terminal 1 to 4	Motor runs	Repair fuse link Q, negative battery clamp disconnected.
C245 terminal 2	Battery voltage	Next step
Jumper radiator temperature switch C245	Motor RUNS	If vehicle has been overheating, replace switch after engine coolant has cooled and pressure has been released
C245 terminal 2	Battery voltage	Replace fan diode assembly

3. RADIATOR BLOWER MOTOR INOPERATIVE WITH A/C ON

NOTE: With engine running ECU may delay radiator blower motor up to 30 seconds

Engine RUNNING, a/c controls ON, cooling fan relay removed

TEST	OK	NOT OK
C245 terminal 2	Battery voltage	Replace fan diode assembly

HEAVY DUTY COOLING-4L (OPTION)

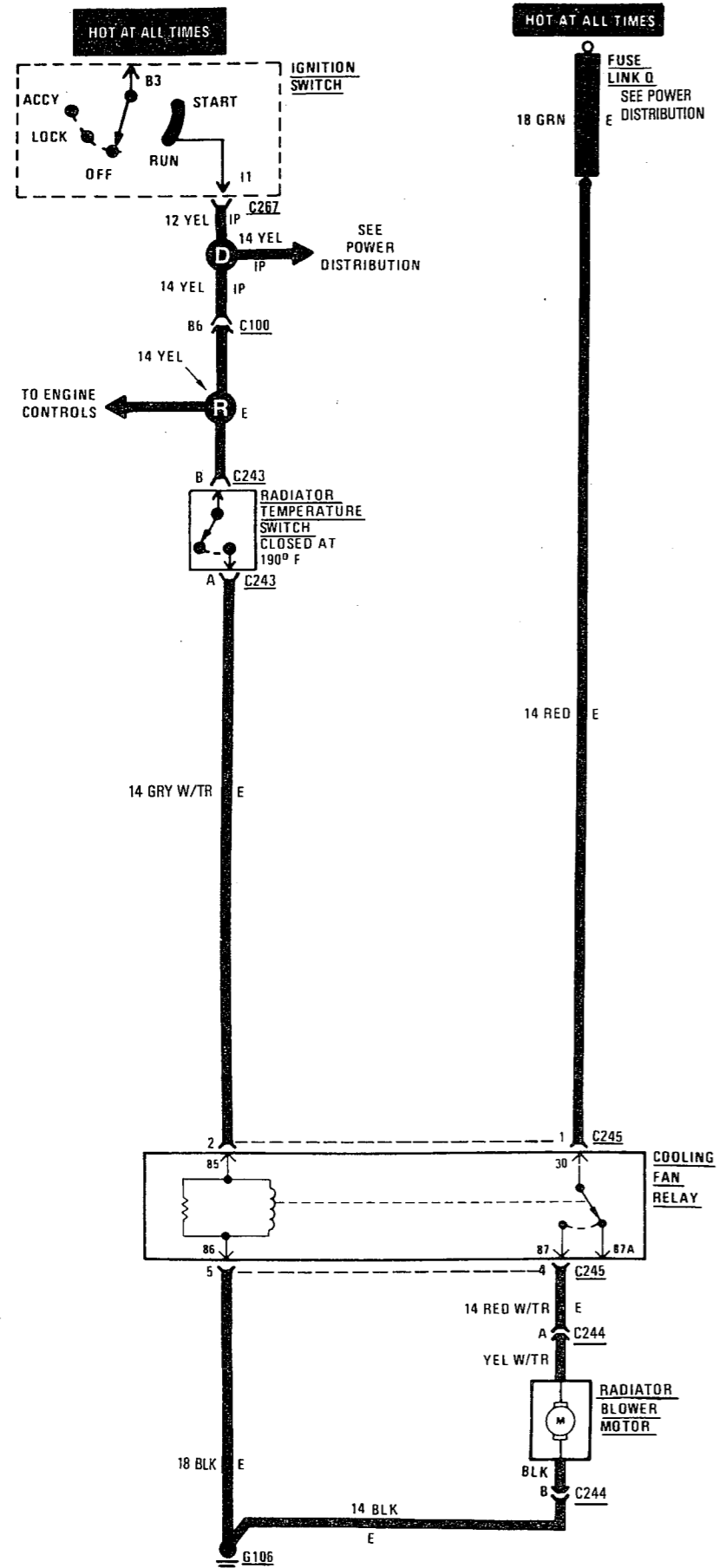

AVAILABLE WIRING FOR DEALER INSTALLED A/C (WITH HEAVY-DUTY COOLING ONLY)

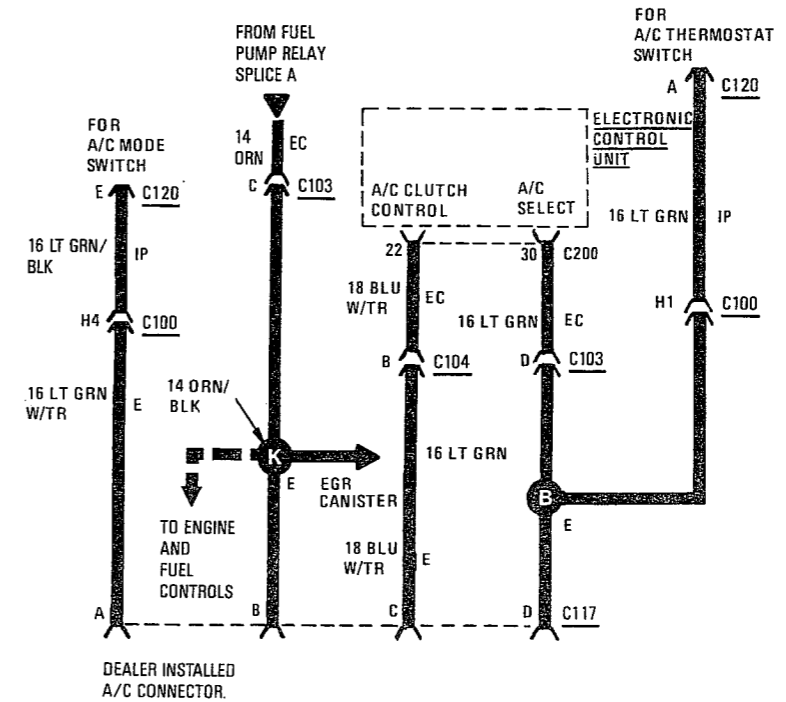

HEAVY DUTY COOLING-4L (OPTION)

DESCRIPTION

The radiator blower motor operates through the cooling fan relay. The relay is energized by the radiator temperature switch.

The closing of the switch provides battery voltage to the motor from fuse link Q.

TROUBLESHOOTING

1. RADIATOR BLOWER MOTOR

Cooling fan relay removed

TEST	OK	NOT OK
Jumper fused test lead, battery to C245 terminal 4	Motor runs	Check ground G106 If ground is good, replace motor

2. COOLING FAN RELAY

Cooling fan relay removed, ignition in run

TEST	OK	NOT OK
C245 terminal 5	Zero ohms	Repair open to ground G106
Jumper fused test lead, C245 terminal 1 to 4	Motor runs	Repair fuse link Q, negative battery clamp disconnected
C245 terminal 2	Battery voltage	Next step
Jumper Radiator Temperature Switch C243	Motor runs	If vehicle has been overheating, replace switch after engine coolant has cooled and pressure has been released. Check Thermostat.

WIPERS/WASHERS

INTERMITTENT

NON-INTERMITTENT

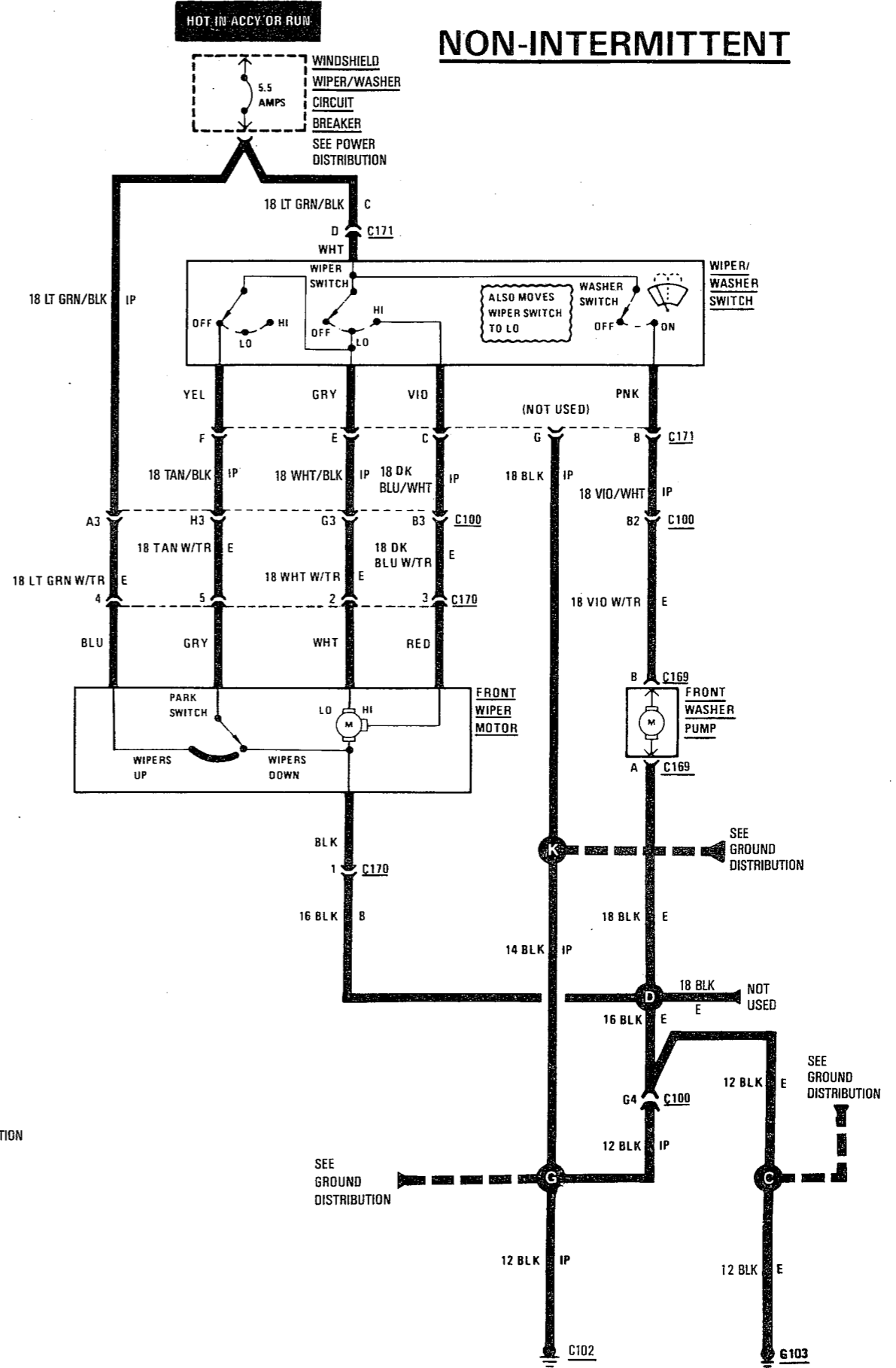
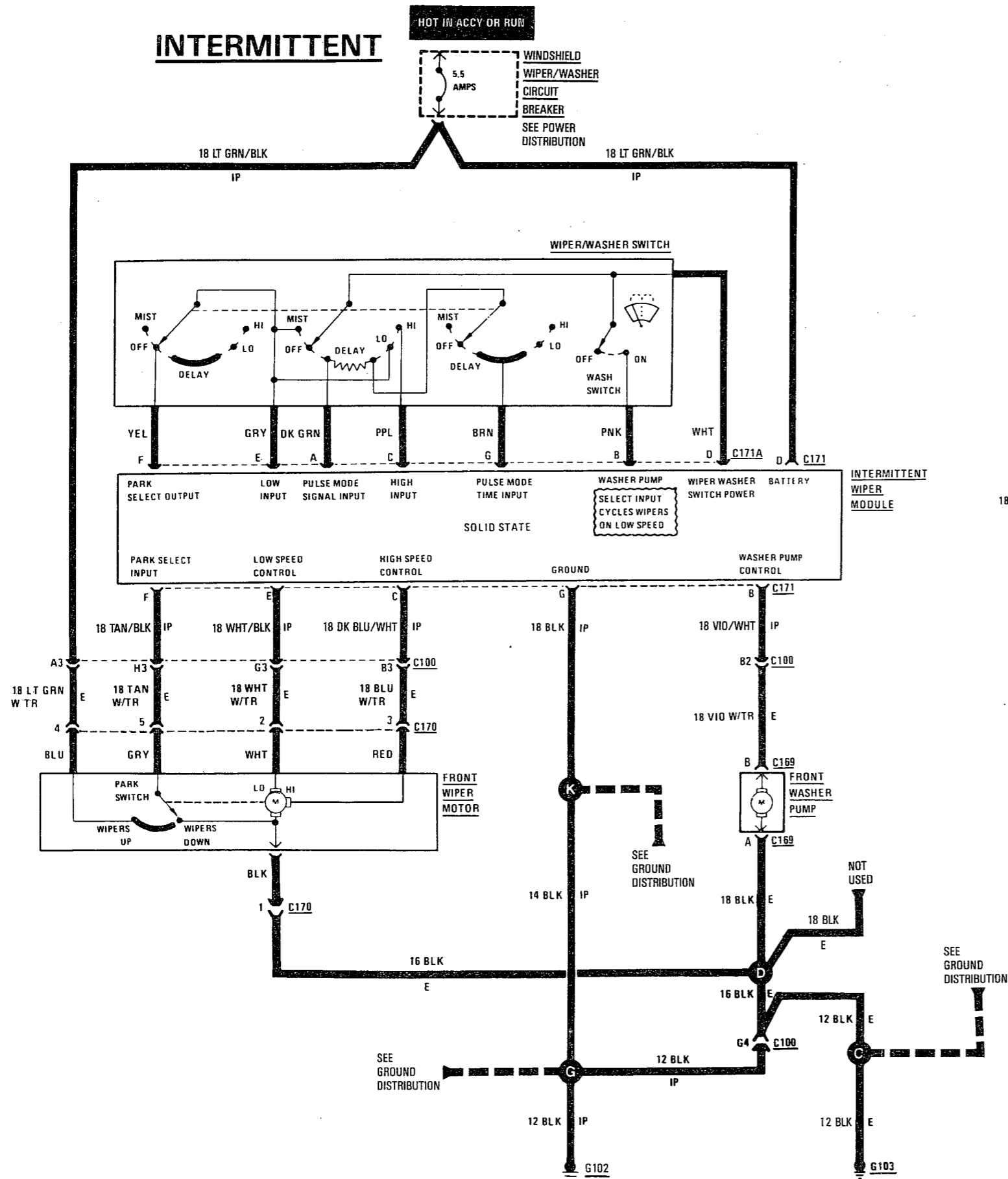

WIPERS/WASHERS

DESCRIPTION — WIPERS

The standard windshield wiper circuit contains three components — wiper/washer switch, motor, and front washer pump. Both standard and intermittent circuits are the same, except that the intermittent circuit requires a module and delay resistance in the wiper switch. Both circuits receive battery feed from, and are protected by a 5.5 amp circuit breaker.

In the standard wiper circuit, the switch connects the motor directly to battery feed for LO and HI speed operation. In the intermittent circuit, the switch supplies battery feed to the intermittent wiper module, which then supplies the motor. In the delay position, the module is connected with the variable resistor in the wiper switch. The value of the

resistance is used by the solid state module to charge a capacitor, which triggers the amount of delay between wipes.

The motor in both circuits is identical, with an arrangement of brushes providing the two wiper speeds. The park circuit is also the same. When the wipers are turned off, the park switch maintains current to the motor until the wipers reach the PARK position on the windshield.

The park arm in the motor assembly is connected to the park switch and is driven by the motor. When the wiper/washer switch is turned to OFF, current flows through the contact and the module to the motor until the wipers reach the park position.

TROUBLESHOOTING — WINDSHIELD WIPERS

1. POWER INPUT

Remove circuit breaker

TEST	OK	NOT OK
Battery side of circuit breaker	Battery voltage	Repair open to Splice E Refer to power distribution
Across circuit breaker terminals	Zero ohms	Replace circuit breaker

2. GROUND

Connector C171 unplugged

TEST	OK	NOT OK
C171 terminal G	Zero ohms	Repair open to ground G102

3. WITH INTERMITTENT WIPERS

Ignition switch in ACCY

TEST	OK	NOT OK
Remove delay module and plug connectors together from the module	Wipers operate in LO and HI speed modes and Mist (washer) is working If wipers and Mist now operate, replace intermittent module.	Go to Test 4.

4. WIPER/WASHER SWITCH

Ignition in RUN, wiper switch position as indicated, back probe switch side of connector C171 for standard, C171A for intermittent

TEST	OK	NOT OK
Connector terminal E — wiper switch in LO and mist/intermittent	Battery voltage	Replace switch
Connector terminal C — wiper switch in HI	Battery voltage	Replace switch
Connector terminal F — wiper switch to OFF	Battery voltage until wipers park and then zero volts	Replace switch

5. WITH INTERMITTENT WIPERS

Connector C171A unplugged

TEST	OK	NOT OK
Across terminals A and D while rotating switch from minimum delay to maximum delay	0-500K ohms	Replace switch
Across terminals A and G while rotating switch from minimum delay to maximum delay	0-500K ohms If OK, replace wiper module	Replace switch

6. WIPER MOTOR

Ignition in ACCY, wiper switch position as indicated, probe C170

TEST	OK	NOT OK
Connector terminal 1	Zero ohms	Repair open to ground G102
Connector terminal 4 — wiper switch in any position	Battery voltage If OK, replace motor	Repair open from fuse panel
Connector terminal 2 — wiper switch in LO	Battery voltage If OK, replace motor	Repair open from wiper switch
Connector terminal 3 — wiper switch in HI	Battery voltage If OK, replace motor	Repair open from wiper switch
Connector terminal 5 — wiper switch to OFF with voltmeter connected	Battery voltage until wipers park and then zero volts IF OK, replace motor	Repair open from wiper switch

WIPERS/WASHERS

DESCRIPTION — WASHERS

With the washer switch in ON, current flows through the washer pump to ground. The front washer pump runs as long as the driver holds the switch in ON. On standard wipers, the washer switch automatically moves the wiper switch to LO when the washer is on. On intermittent wipers, the wiper module runs the wiper motor on LO. Turning the switch to OFF stops the wipers.

TROUBLESHOOTING — WINDSHIELD WASHER (STANDARD)

1. GROUND

Connector C169 unplugged

TEST	OK	NOT OK
Terminal A at pump to clean chassis ground	Zero ohms	Repair open to ground G102/G103

2. POWER INPUT

Ignition in ACCY, washer switch to ON

TEST	OK	NOT OK
C169 terminal B at pump	Battery voltage If OK, replace washer pump	Go to next step
C171 terminal B at switch	Battery voltage If OK, repair open to washer pump	Replace switch

TROUBLESHOOTING — WINDSHIELD WASHER (INTERMITTENT)

1. GROUND

Connector C169 unplugged

TEST	OK	NOT OK
Terminal A at pump to clean chassis ground	Zero ohms	Repair open to ground G102/G103

2. POWER INPUT

Ignition switch in ACCY, washer switch to ON

TEST	OK	NOT OK
C171A terminal B	Battery voltage	Replace wiper switch
C171 terminal B	Battery voltage	Replace module
C169 terminal B at pump	Battery voltage If OK, replace pump	Repair open from Wiper Module

CHIME MODULE

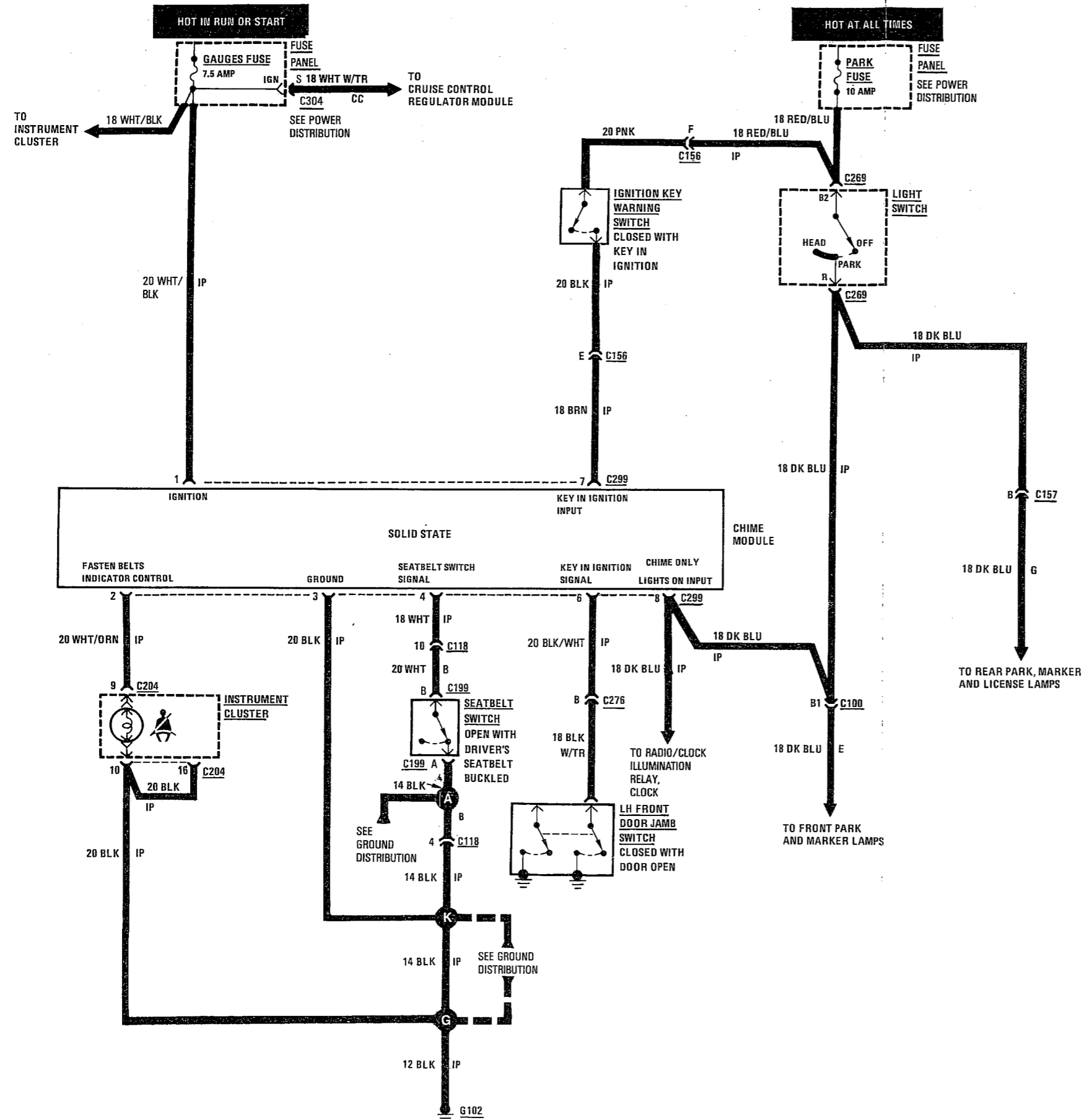

CHIME MODULE

DESCRIPTION

The chime module system calls attention to several conditions by sounding a built-in chime. These conditions are: 1) the LH front seatbelt is not buckled, 2) the key is in the ignition and the LH front door is open, and 3) the vehicle lights are on after the ignition switch is in OFF. The solid state chime module detects these conditions and produces chime pulses at a different rate for each one. It also applies steady voltage to light a fasten belts indicator in the instrument.

Battery voltage to operate the module is supplied at three terminals of the module. When the key is in the ignition switch, voltage is present at terminal 7. Terminal 8 receives voltage from the light switch whenever the headlights or parklights are on. Terminal 1 receives voltage in RUN or START.

To sound the seatbelt warning, two inputs to the module must be present: 1) battery voltage at the ignition switch input, and 2) a ground at the seatbelt input. This occurs when the seatbelt switch is closed because the LH seatbelt is not buckled. While the slow chime sounds, the module also supplies steady battery voltage to the fastened belt output to light the indicator.

To sound the key in ignition warning, both the ignition key warning switch and the LH front door jamb switch must be closed. This condition grounds terminal 6 of the module. These switches are closed when the LH front door is open and the key is in the ignition.

The lights-on warning sounds when voltage is present at the lights-on input, and not present at the ignition switch input. If either of these changes lights OFF or ignition ON, the fast pulsed lights-on chime will stop.

TROUBLESHOOTING

1. CHIME MODULE

Ignition in RUN

TEST	OK	NOT OK
Apply parking brake	Parking indicator lights	Replace Gauges fuse
C299 terminal 1*	Battery voltage	Repair open to fuse
C299 terminal 3	Zero ohms	Repair open to splice K
C299 terminal 2	Almost zero ohms (bulb filament)	Replace indicator bulb
C299 terminal 4	Zero ohms	Repair open to splice G
C299 terminal 6 LH door open	Zero ohms	Repair open to ground side of door jamb switch
C299 terminal 7	Battery voltage	Repair open to C156, terminal F
C299 terminal 8 — headlamp switch in park	Battery voltage If OK, replace module	Repair open to C100, terminal B1

* Remove chime module from fuse panel.

HORNS

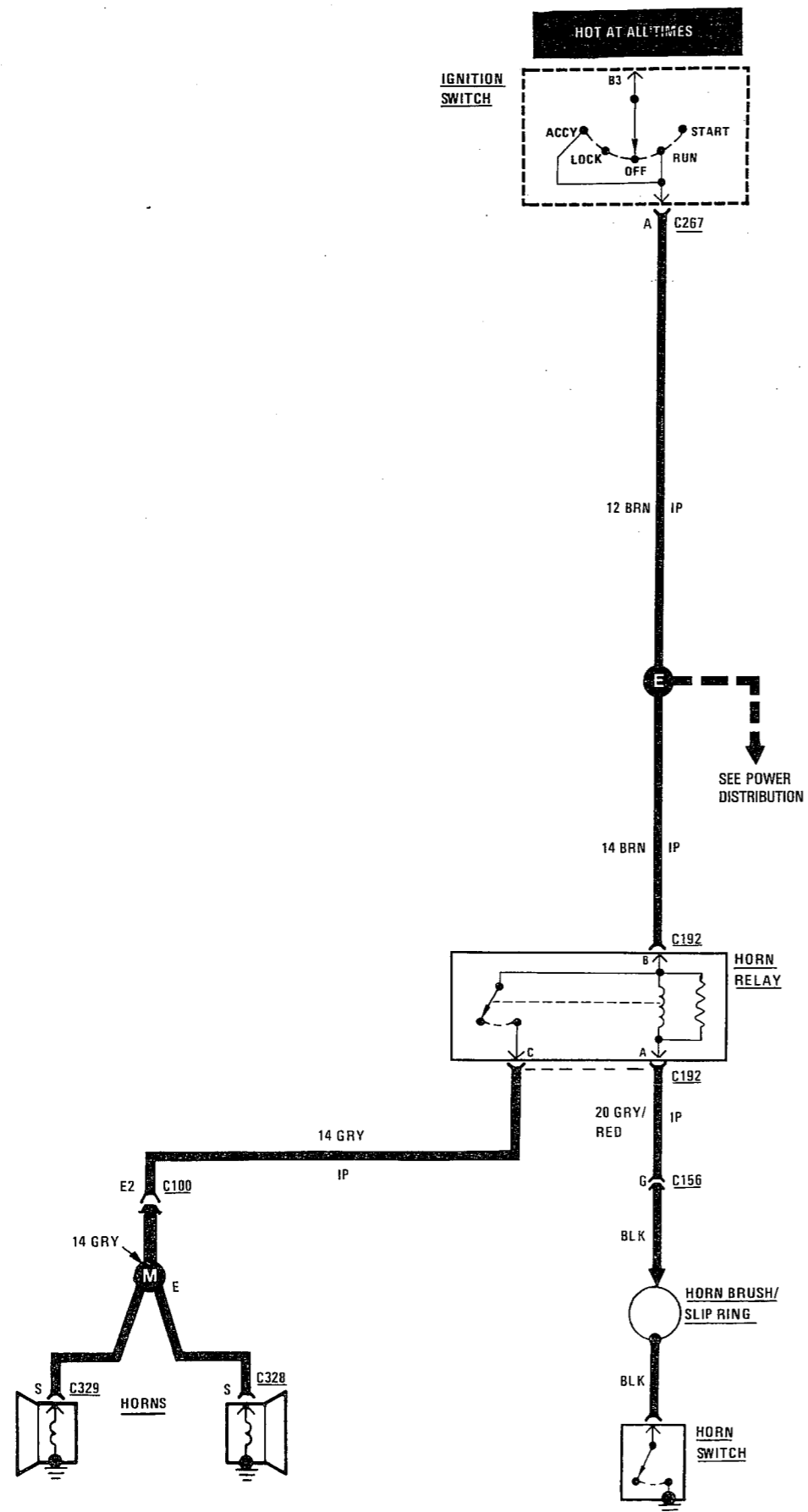

DESCRIPTION

Battery voltage is applied to the horn relay when the ignition switch is in RUN or ACCY. When the horn switch is depressed, the horn relay is grounded, pulling the contact closed and providing battery voltage to the horns. The horns will sound.

TROUBLESHOOTING

1. HORN RELAY

Ignition in ACCY

TEST	OK	NOT OK
Depress Horn Switch	Relay contacts click If OK, go to step 2	Next step
C192 terminal B*	Battery voltage	Repair open to Splice E
C192 terminal A**	Zero ohms	Repair open to Horn Switch ground
C192 terminal C	Almost zero ohms (horn resistance) If OK, replace relay	Repair open to Splice M

* Remove relay.

**Horn Switch depressed.

2. HORNS

Ignition in ACCY, unplug horn connector, depress horn switch

TEST	OK	NOT OK
C328/C329 terminals	Battery voltage If OK, replace horns	Repair open to relay

CRUISE CONTROL

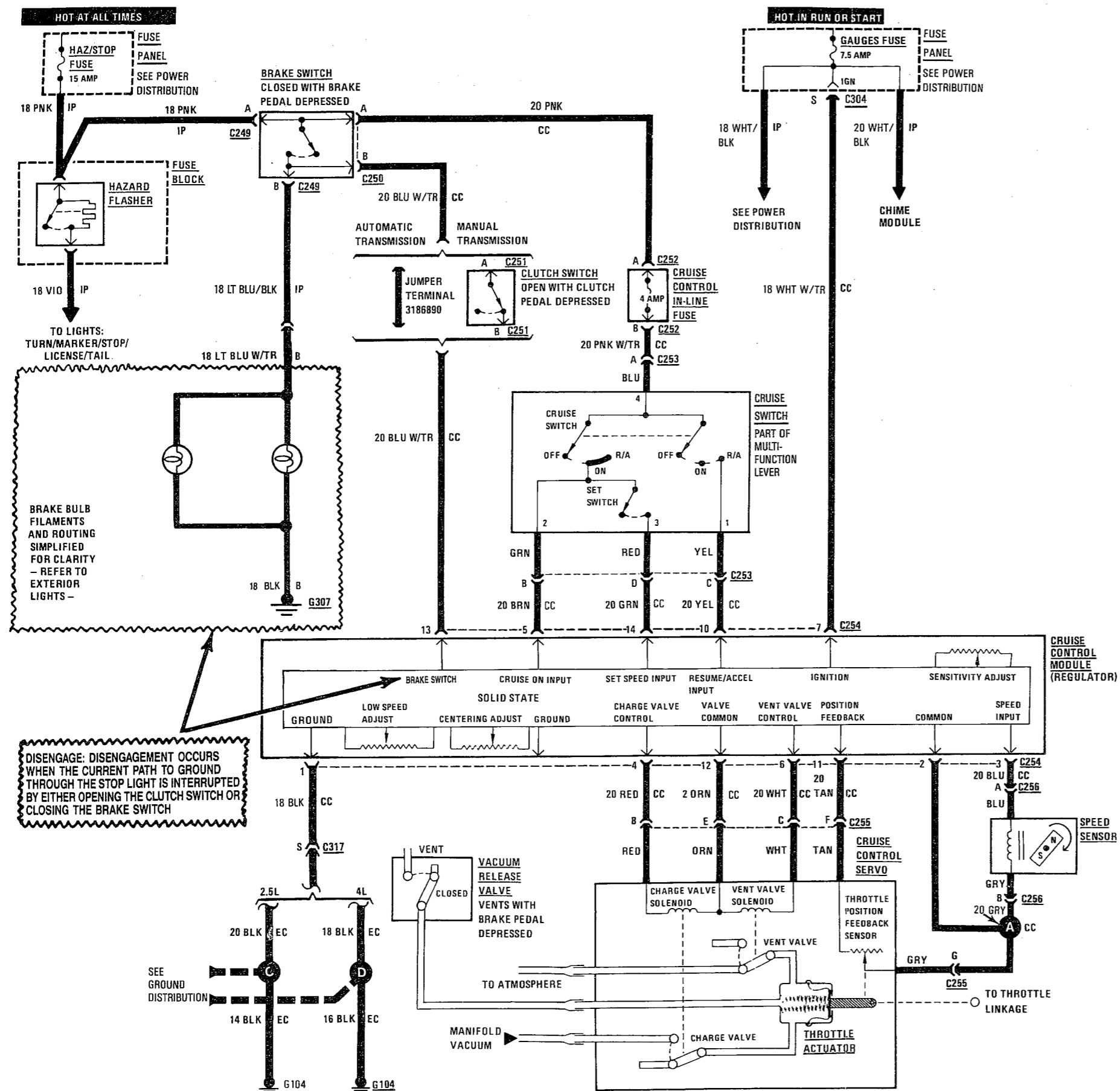

CRUISE CONTROL

DESCRIPTION

The cruise control module automatically controls throttle position to maintain a speed set by the operator. The vehicle will keep the set speed unless the driver presses the brake, clutch or accelerator pedal.

The ACCY fuse supplies voltage to the cruise control module with the ignition switch in the RUN position. The HAZ/STOP fuse provides battery feed to the brake switch, cruise control fuse, and the multi-function lever at all times.

When the multi-function lever is in the ON position, voltage is applied to terminal 14 (speed set signal) and terminal 5 (cruise ON input).

The driver opens the set switch when the vehicle is at the set speed. Voltage to the speed set signal stops momentarily. The cruise regulator records the vehicle's speed at the moment there is no voltage at terminal 14 (speed set signal).

The resume/accelerate switch is used after the cruise control module has been interrupted by the current path to ground through the stop lights at terminal 13. This path is broken by the use of the brake or clutch pedals or when the driver wants to accelerate. When the switch is in the R/A position, voltage is applied to the resume/accelerate input (terminal 10). The cruise control module recognizes this voltage as an instruction to accelerate. When the switch is pushed into the R/A position and released immediately, voltage is applied only momentarily to terminal 10. The cruise control module interprets this voltage as an instruction to resume the previously set speed.

The cruise control module controls the servo on the basis of these voltages, the speed signal from the speed sensor and the position feedback input from that servo. The cruise control module will energize the charge valve in the servo allowing

vacuum to retract the bellow when acceleration is needed. During deceleration, the cruise control module will de-energize the vent valve and release the vacuum in the servo.

OPERATIONAL CHECK (ROAD TEST)

The following sequential checks are performed with the cruise switch ON and vehicle speed faster than 35 mph:

1. Press the set button at the end of multi-function lever. Vehicle should maintain set speed.
2. Hold set button in, and remove foot from accelerator. Vehicle should coast to a slower speed.
3. Release set button. Cruise control will engage and hold a slower speed, provided the speed remains above 35 mph.
4. Slide cruise switch to R/A and hold it there. Vehicle should accelerate.
5. Release cruise switch back to ON. Vehicle will hold the new faster speed, if set speed button has been pressed.
6. Tap brake pedal. Vehicle will decelerate.
If the vehicle has a manual transmission, repeat step 6 by depressing the clutch.
7. Slide cruise switch momentarily R/A. Vehicle will accelerate to former set speed.
8. While cruising, accelerate, then remove foot from accelerator. Vehicle will coast back to set speed.
9. While cruise is engaged, tap set speed button. Vehicle speed will increase 1 mph for each time set speed button is tapped.

AM PC-1-R CRUISE CONTROL TESTER

The following troubleshooting charts are based on the results obtained from AMPC-1-R Cruise Control Tester.

To install the tester, remove the control module attaching screws, unplug the wiring connector and plug it into the tester. Disconnect and connect all cruise control connectors before testing to remove oxidation that may have formed on the connector terminals.

CAUTION: When separating wiring harness connectors do not pull on the wires. PULL ONLY ON THE CONNECTORS.

Proceed through the diagnostic chart and its instructions. Complete the entire test sequence even though a tester lamp may not come on.

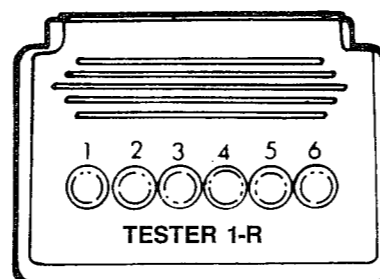

If the tester fails the system, refer to the appropriate Lamp Out TROUBLESHOOTING CHART for component and circuit diagnosis.

CRUISE CONTROL TESTER DIAGNOSTIC CHART

NOTE: Lamp No. 2 will remain lit during all tests. If no lamps light, go to Test No. 1.

MINIMUM OPERATION REQUIRED TO TURN ON LAMP	LAMP ON						TEST NUMBER
	1	2	3	4	5	6	
A. CRUISE SWITCH ON • Set Switch Depressed	X						2
B. CRUISE SWITCH ON		X					3
C. IGNITION SWITCH ON • Depress Brake or Clutch To Turn OFF			X	X			4, 5
D. CRUISE SWITCH RESUME/ACCELERATE					X	X	6

SERVO CHECKS

E. CRUISE SWITCH RESUME/ACCELERATE • Engine Running • Parking brake fully engaged; automatic transmission in PARK; manual transmission in NEUTRAL						X	X	7A, 7B
---	--	--	--	--	--	---	---	--------

WARNING: Servo will pull throttle wide open. Keep RPM at a safe limit by releasing the cruise switch.

TROUBLESHOOTING

1. NO LAMPS WILL LIGHT

Ignition in OFF

TEST	OK	NOT OK
C254 terminal 1 to chassis ground	Zero ohms	Repair open to G104

2. LAMP NO. 1 WILL NOT LIGHT

Remove and inspect fuse, Ignition in RUN, Cruise Switch in ON, Set Switch DEPRESSED

TEST	OK	NOT OK
HAZ/STOP fuse	Not blown	Replace fuse
In-line fuse	Not blown	Replace fuse
Connector C252 terminal A	Battery voltage	Repair open from Brake Switch
C253 terminal A*	Battery voltage	Repair open from In-line Fuse
C253 terminal D*	Battery voltage	Replace Cruise Switch
C254 terminal 14*	Battery voltage	Repair open from Cruise Switch

* Backprobe connector

CRUISE CONTROL

3. LAMP NO. 2 WILL NOT LIGHT

Ignition in ON, Cruise Switch in ON

TEST	OK	NOT OK
C253 terminal B	Battery voltage	Replace Cruise Switch
C254 terminal 5	Battery voltage	Repair open from Cruise Switch
Across C254 terminals 2 and 3	15-50 ohms	Go to next step
Across C256 terminals A and B	15-50 ohms If OK, repair open to module	Go to next step
C256 terminals A and B with rear wheels spinning	At 30 mph, 0.9v AC voltage should increase 0.1v AC per each 10 mph	Replace Speed Sensor

4. LAMP NO. 3 WILL NOT LIGHT

Ignition in RUN

TEST	OK	NOT OK
C254 terminal 7	Battery voltage	Repair open from GAUGES Fuse
Jumper wire between C254 terminals 7 and 13	Stop Lamps light	Repair open in brake/clutch switch circuit

5. LAMP NO. 4 WILL NOT LIGHT

Ignition in RUN

TEST	OK	NOT OK
Gauges fuse	Not blown	Replace fuse
C254 terminals 2 and 11 while moving throttle from idle to wide open	240-4K ohms	Go to next step
C255 terminals G and F while moving throttle from idle to wide open	280-430 ohms at idle 4K (4000) ohms at wide open If both tests OK, repair open to Control Module	Replace Control Servo

6. LAMP NO.'S 5 AND 6 WILL NOT LIGHT

Ignition in RUN, Cruise Switch in R/A

TEST	OK	NOT OK
C253 terminal C	Battery voltage	Replace Cruise Switch
C254 terminal 10	Battery voltage	Repair open from Cruise Switch
Across C254 terminals 6 and 12	30-50 ohms	Go to Servo checks
Across C254 terminals 4 and 12	30-50 ohms	Go to Servo checks
C254 terminal 6 to clean chassis ground	Infinite resistance (OPEN)	Replace Control Servo
C254 terminal 4 to clean chassis ground	Infinite resistance (OPEN)	Replace Control Servo
C254 terminal 12 to clean chassis ground	Infinite resistance (OPEN)	Replace Control Servo

SERVO CHECKS

7A. HOSE ROUTING AND SERVO CABLE

TEST	OK	NOT OK
Inspect the following: <ul style="list-style-type: none"> Servo cable for breaks and hook-up. Engine vacuum can and hose connections (small hose) 	Proper connection	Repair as required

7B. BRAKE VENT VALVE HOSE AND SERVO

TEST	OK	NOT OK
Pinch brake vent hose (large hose) at servo and repeat Servo Check test E	Servo operates If OK, inspect vent hose for kinks, cuts or other damage. Also check brake vent valve adjustment.	Replace Control Servo

CRUISE CONTROL

CRUISE CONTROL MODULE TEST

The cruise control module adjustments are pre-set. If all other components of the system appear to be functioning normally and the cruise control remains inoperative, perform the following adjustments to determine if the module is functional.

CAUTION: The adjustments are extremely delicate. Insert the screwdriver into the slots VERY CAREFULLY. Do not push hard or turn hard against the stops. The arms have a maximum turning angle of 270 degrees (three-quarter turn).

Verify if the cruise control module is not working by using the indicated settings:

Turn the centering adjustment to the 10 o'clock position (A).

Turn the low speed switch adjustment to the 10 o'clock position (B).

Turn the sensitivity adjustment full clockwise (C).

NOTE: The adjustments may not be precisely correct for the vehicle, but are acceptable to determine if the regulator module is functioning. The need for more precise adjustments can be determined by a road test.

If the adjustments have no effect on the cruise control operation, replace the cruise control module.

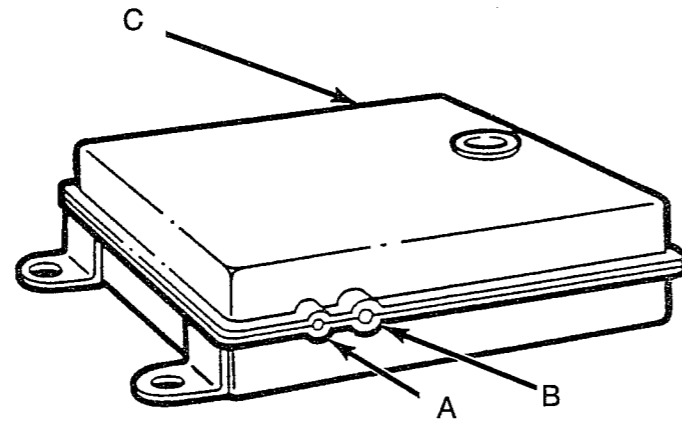

CENTERING ADJUSTMENT LOW SPEED SWITCH ADJUSTMENT SENSITIVITY ADJUSTMENT

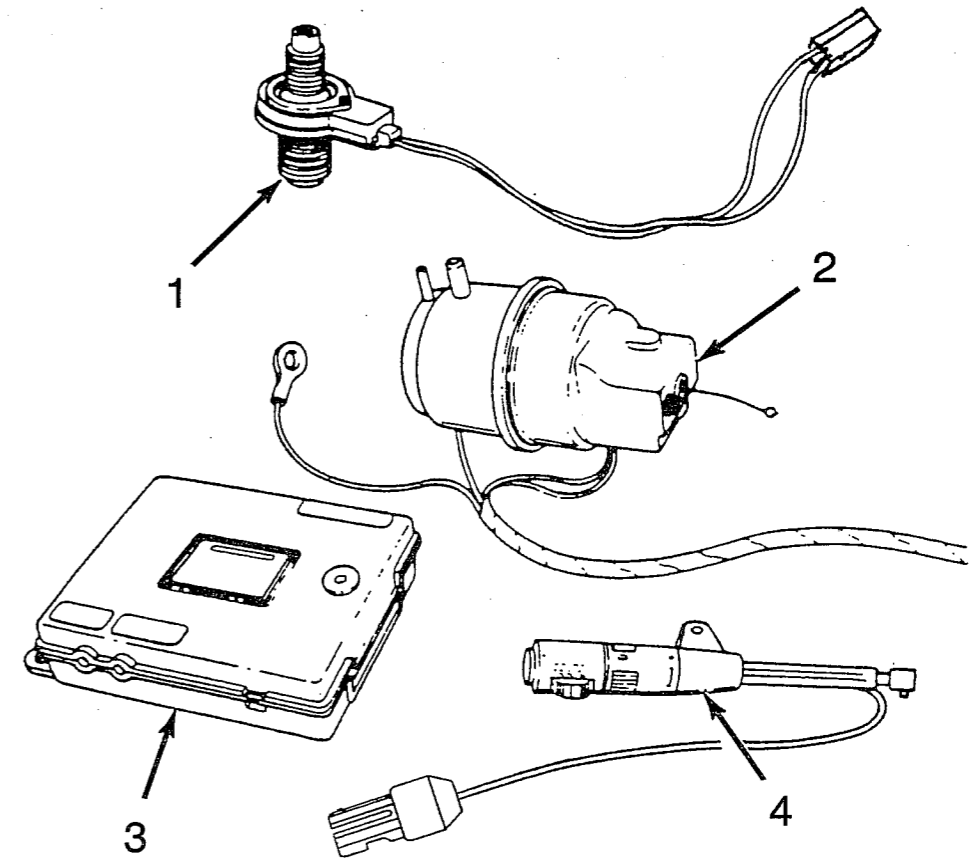
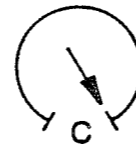
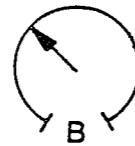
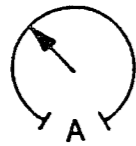

1. Speed Sensor
2. Servo
3. Regulator (Cruise Control Module)
4. Control Switch

POWER DOOR LOCKS WITHOUT POWER WINDOWS

2-DOOR

POWER DOOR LOCKS WITH POWER WINDOWS

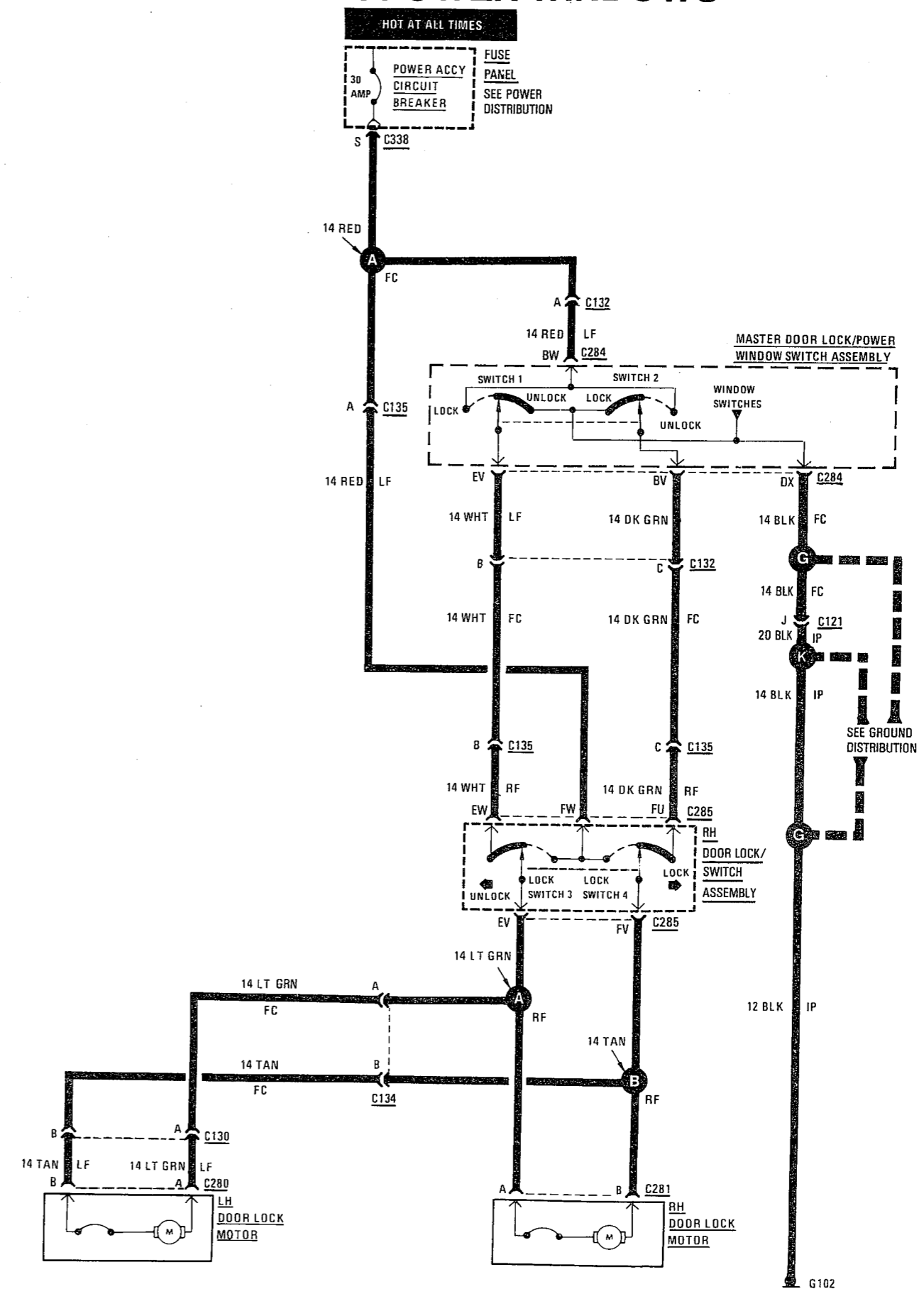
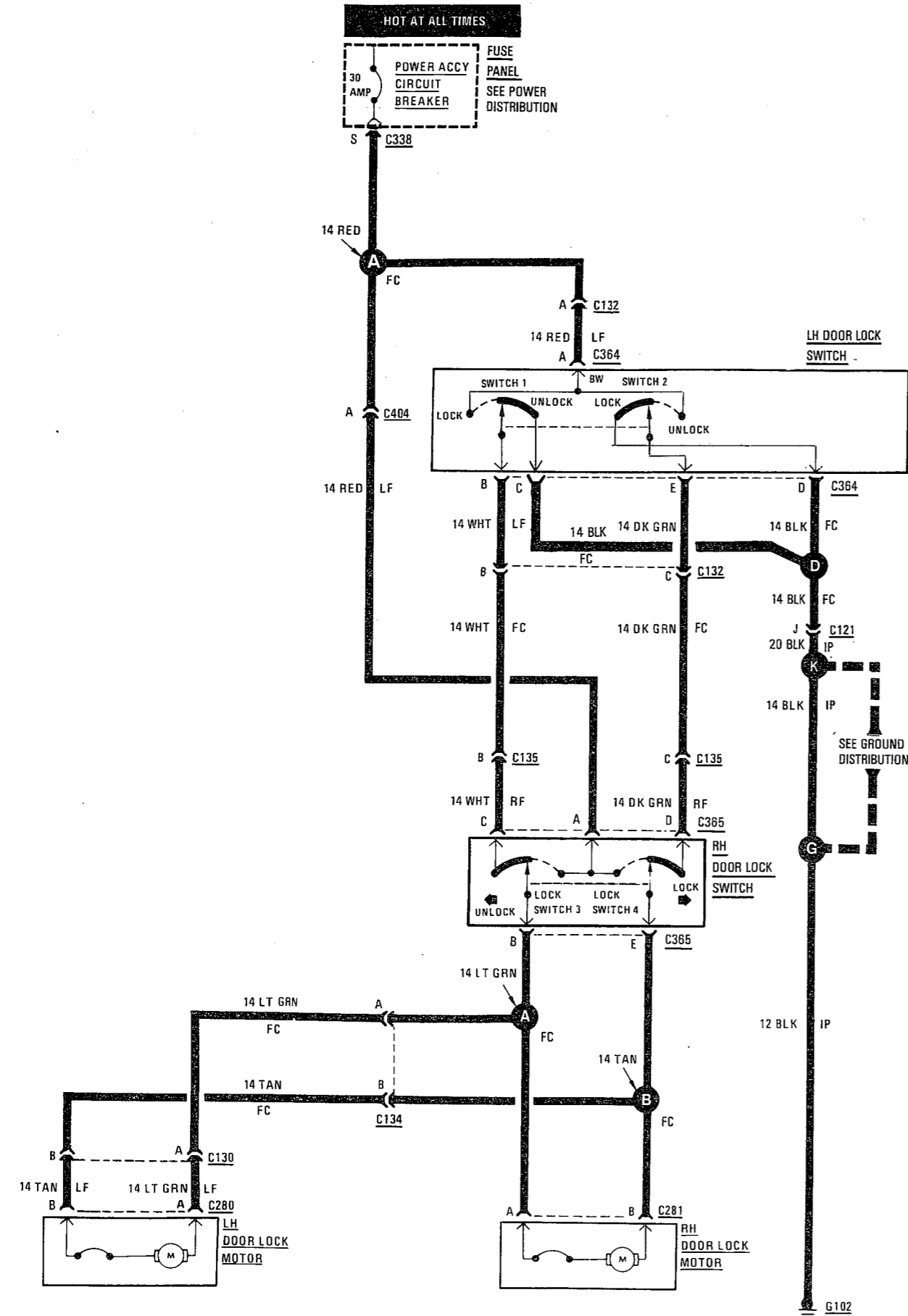

POWER DOOR LOCKS

DESCRIPTION

The door locks are operated by reversible motors that receive voltage from the power accy circuit breaker. Voltage is applied to the LH door lock switch and the RH door lock window switch. With the LH door lock switch in LOCK, voltage is applied through the switch 1 to the RH door lock window switch, then from switch 3 to terminal A of each door lock motor. The ground path while switch 1 is in LOCK is through terminal B of the door lock motor, then switch 4 of

the RH door lock window, and to the lock contact of switch 2 to G102.

When the RH door lock window switch is in the LOCK position voltage is applied from switch 3 to terminal A of the door lock motors. The ground path is through terminal B of the door lock motors to switch 4, then switch 2 and G102. The voltage and ground paths are reversed to unlock the doors.

TROUBLESHOOTING

1. NO DOOR LOCKS OPERATE

Power ACCY circuit breaker installed

TEST	OK	NOT OK
Probe C338 on Fuse Panel	Battery voltage	Replace circuit breaker
Probe RED wire at LH switch*	Battery voltage	Repair open to circuit breaker
Probe BLK wire at LH switch**	Zero ohms	Repair open to C121 terminal J
Perform Switch Testing on LH Door Lock Switch	Passes test	Replace LH Door Lock Switch

* Remove mounting screws of LH switch.

** Power Door Locks w/o Windows has 2 BLK wires, probe both.

2. RH DOOR LOCK SWITCH

Remove mounting screws of RH switch

TEST	OK	NOT OK
Probe WHT wire at RH switch	Zero ohms	Repair open to LH switch
Probe DK GRN wire at RH switch	Zero ohms	Repair open to LH switch
Perform Switch Testing on RH Door Lock Switch	Passes test If OK, replace both Door Lock motors	Replace RH Door Lock Switch

1. RH DOOR LOCK SWITCH INOPERATIVE

Remove RH switch mounting screws

TEST	OK	NOT OK
Probe RED wire at switch	Battery voltage If OK, replace switch	Repair open to Splice A

1. ONE OR MORE DOOR LOCK MOTORS INOPERATIVE

Remove door panel of inoperative motor, unplug motor connector

TEST	OK	NOT OK
Harness side of motor connector terminal A	Zero ohms	Repair open to RH Door Lock Switch
Harness side of motor connector terminal B	Zero ohms If OK, replace Motor	Repair open to RH Door Lock Switch.

POWER WINDOWS

DESCRIPTION

A permanent magnet motor moves each of the power windows. Each motor raises or lowers the glass when voltage is supplied to the motor. The direction the motor turns depends on the polarity of the supply voltage. The control switches control the supply voltage polarity.

With the ignition switch in RUN, voltage is applied through the power window circuit breaker VIO wire to the master switch assembly and to the passenger's window switches.

When the driver's window switch is moved UP, the contacts close a current path to the YEL wire, the LH front window motor, the LT BLU wire, and the DOWN contact of the

LH front window switch to ground G102. The motor moves the glass up.

Current flows in a similar way when the UP contact in one of the passenger's window switches is closed. However, current flow through the passenger's window motors must go through the driver's and the passenger's window switches before it reaches ground.

Each motor is protected by a built-in circuit breaker. If a window switch is held on too long with the window obstructed or after the window is fully up or down, the circuit breaker opens the circuit. The circuit breaker resets automatically as it cools. Do not allow frequent or consecutive resetting of the circuit breaker to continue. Make necessary repairs.

TROUBLESHOOTING

1. NO WINDOWS OPERATE

Power window circuit breaker installed

TEST	OK	NOT OK
Probe C308 on Fuse Panel	Battery voltage	Replace circuit breaker
Side of cigar lighter socket to ground	Zero ohms	Repair open to ground G102
Probe VIO wire at LH switch*	Battery voltage	Repair open to circuit breaker
Probe BLK wire at LH switch	Zero ohms	Repair open to Splice G of I.P. Harness
Operate Window switch	Windows move up and down	Go to Switch Testing See Contents for page number
Master Power Window Switch	Passes test	Replace defective motors

* Remove Master Door Lock/Power Window Switch Assembly mounting screws.

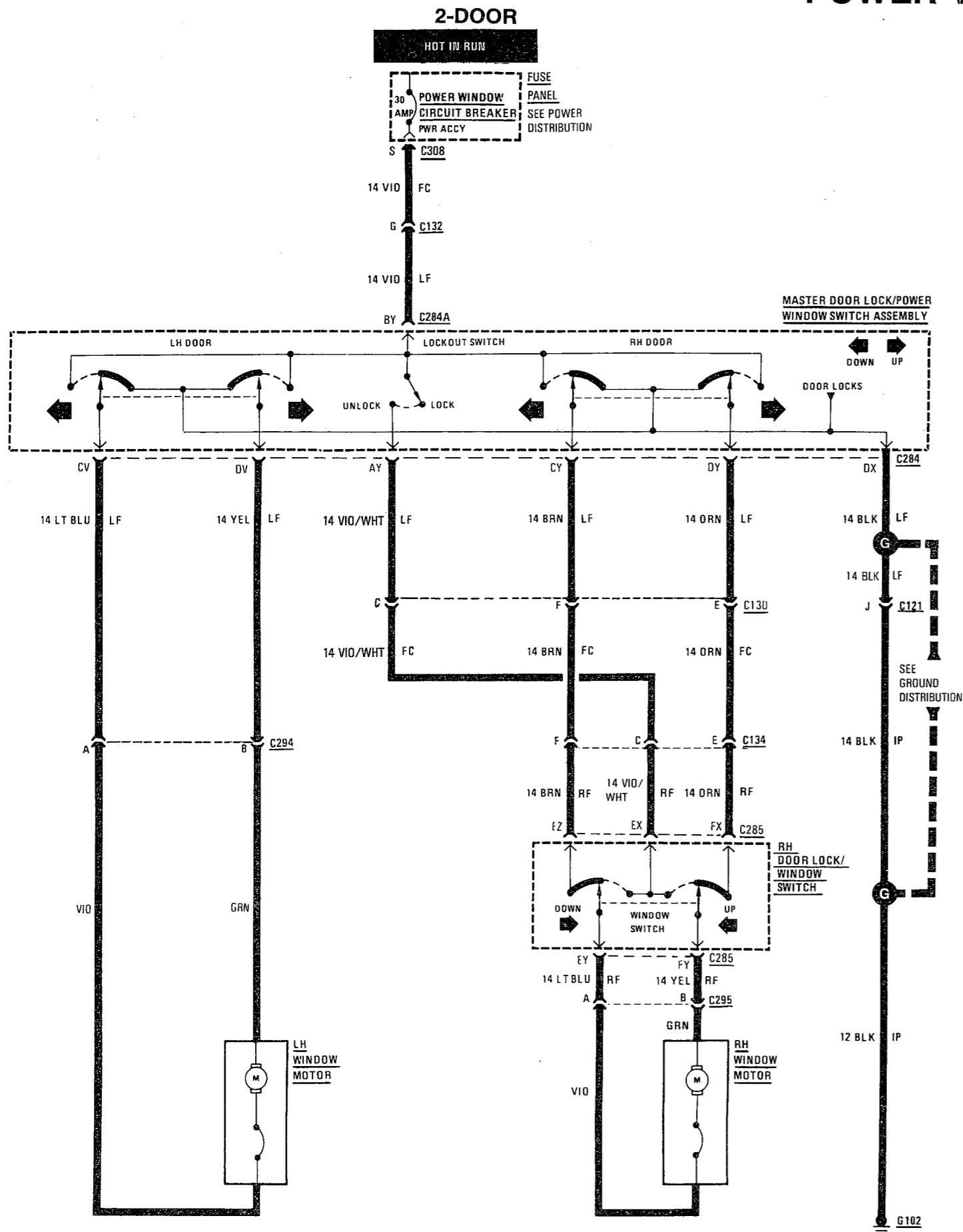

POWER WINDOWS

2. ONE WINDOW OPERATES

Remove door panel of inoperative window, refer to appropriate M.R. probe harness side of unplugged motor connector

TEST	OK	NOT OK
Terminal A of connector, holding switch in the DOWN position	Battery voltage	Repair open back to Master Switch*
Terminal B of connector, holding switch in the DOWN position	Zero ohms, Caution, maintain DOWN position while meter lead is attached.	Repair open back to Master Switch* If both tests are OK, replace motor

*If additional switch is in circuit (not LH motor), refer to Switch Testing.

RADIO

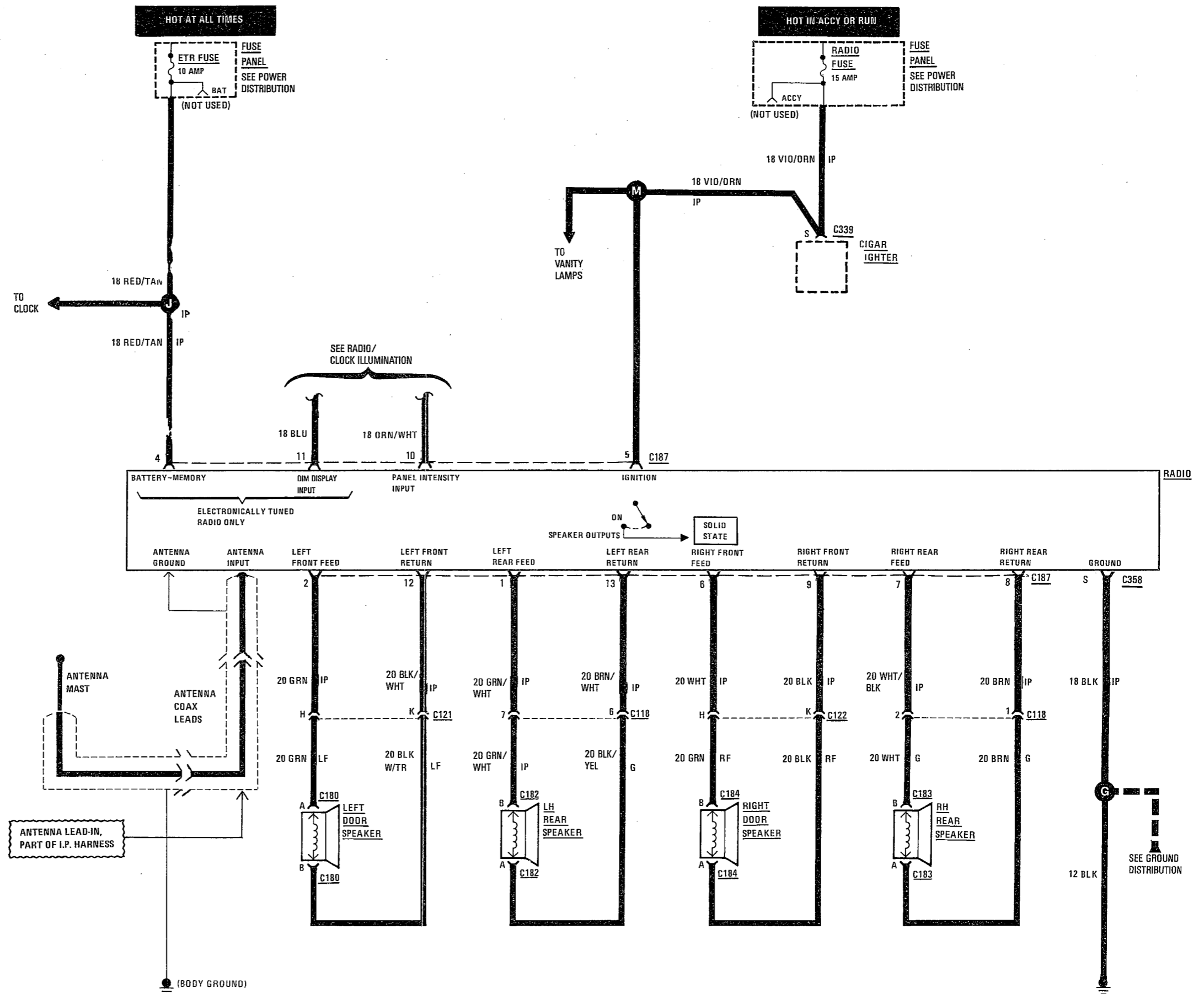

RADIO

DESCRIPTION —

All radios, whether standard or optional receive battery power for station memory from the ETR fuse. When the ignition is in ACCY or RUN, power from the Radio Fuse is supplied to the ignition input. Refer to Radio/Clock Illumination for display information and troubleshooting.

NOTE: Refer to Owner's Manual for proper Radio adjustment.

TROUBLESHOOTING

Troubleshooting Chart Index

CHART NO.	SYMPTOM
1	Radio Inoperative — No Audio Output, No Background Noise
2	No Audio Output on Front Speakers, Rear Speakers OK
3	No Audio Output on Rear Speakers, Front Speakers OK
4	Distorted Audio Output on One or More Speakers
5	Weak or No Reception — No Audio Output, Background Noise Present
6	Memory Inoperative
7	Noise Interference Changes With Engine Speed

1. RADIO INOPERATIVE — NO AUDIO OUTPUT, NO BACKGROUND NOISE

Ignition Switch in RUN

TEST	OK	NOT OK
Inspect Radio Fuse	Not blown	Replace fuse
Connector C358 Terminal S to ground	Zero ohms	Repair open to G102
Substitute known good radio	Problem resolved	Remove original radio for service

NOTE: Cigar Lighter and Radio share the same fuse and ground.

2. NO AUDIO OUTPUT ON FRONT SPEAKERS, REAR SPEAKERS OK

Radio OFF, connector C187 disconnected

TEST	OK	NOT OK
C187 Terminals 2 and 12 (left) Terminals 6 and 9 (right)	5 to 8 ohms If OK, remove radio for service	Repair wiring or replace speakers as required

3. NO AUDIO OUTPUT ON REAR SPEAKERS, FRONT SPEAKERS OK

Radio OFF, connector C187 disconnected

TEST	OK	NOT OK
C187 Terminals 1 and 13 (left) Terminals 7 and 8 (right)	5 to 8 ohms If OK, remove radio for service	Repair wiring or replace speakers as required

4. DISTORTED AUDIO OUTPUT ON ONE OR MORE SPEAKERS

Radio ON

TEST	OK	NOT OK
Substitute known good speaker or speakers	Non-distorted audio output	Remove radio for service

RADIO

5. WEAK OR NO RECEPTION; NO AUDIO OUTPUT; BACKGROUND NOISE PRESENT*

Ignition Switch in RUN, Radio ON

TEST	OK	NOT OK
Check that antenna mast is raised	Mast raised	Go to Power Antenna testing
Inspect antenna cable and connector at radio	Not disconnected, loose, or broken	Reconnect or replace antenna as required
Unplug cable and connectors from radio Center conductor to coaxial shield	Infinite resistance (open)	Replace antenna assembly
Antenna mast to tip of center conductor at radio end of cable	0 to 0.5 ohms	Replace antenna assembly
Coaxial shield to chassis ground (vehicle body)	Zero ohms	Ground antenna base to vehicle body, or replace antenna assembly as required

*For all problems with no or low audio output not resolved by this test, remove radio for service. Refer to Accessory Section of MR244 for removal procedures.

6. MEMORY INOPERATIVE

Battery input

TEST	OK	NOT OK
ETR Fuse	Not blown	Replace fuse
Connector C187 Terminal 4	Battery voltage If OK, remove radio for service	Repair open from Splice J

7. NOISE INTERFERENCE CHANGES WITH ENGINE SPEED

Radio Interference Supression

TEST	OK	NOT OK
Inspection connections at: —Alternator —Ignition module —Antenna coaxial ground —Radio ground —Body to Engine Block (braided ground strap)	Inspection points OK	Repair connections as required
Inspect ignition secondary: —Wire routing —Condition of wire insulation —Distributor rotor	Secondary OK	Reroute or replace wiring Apply silicone grease to rotor tip

CLOCK

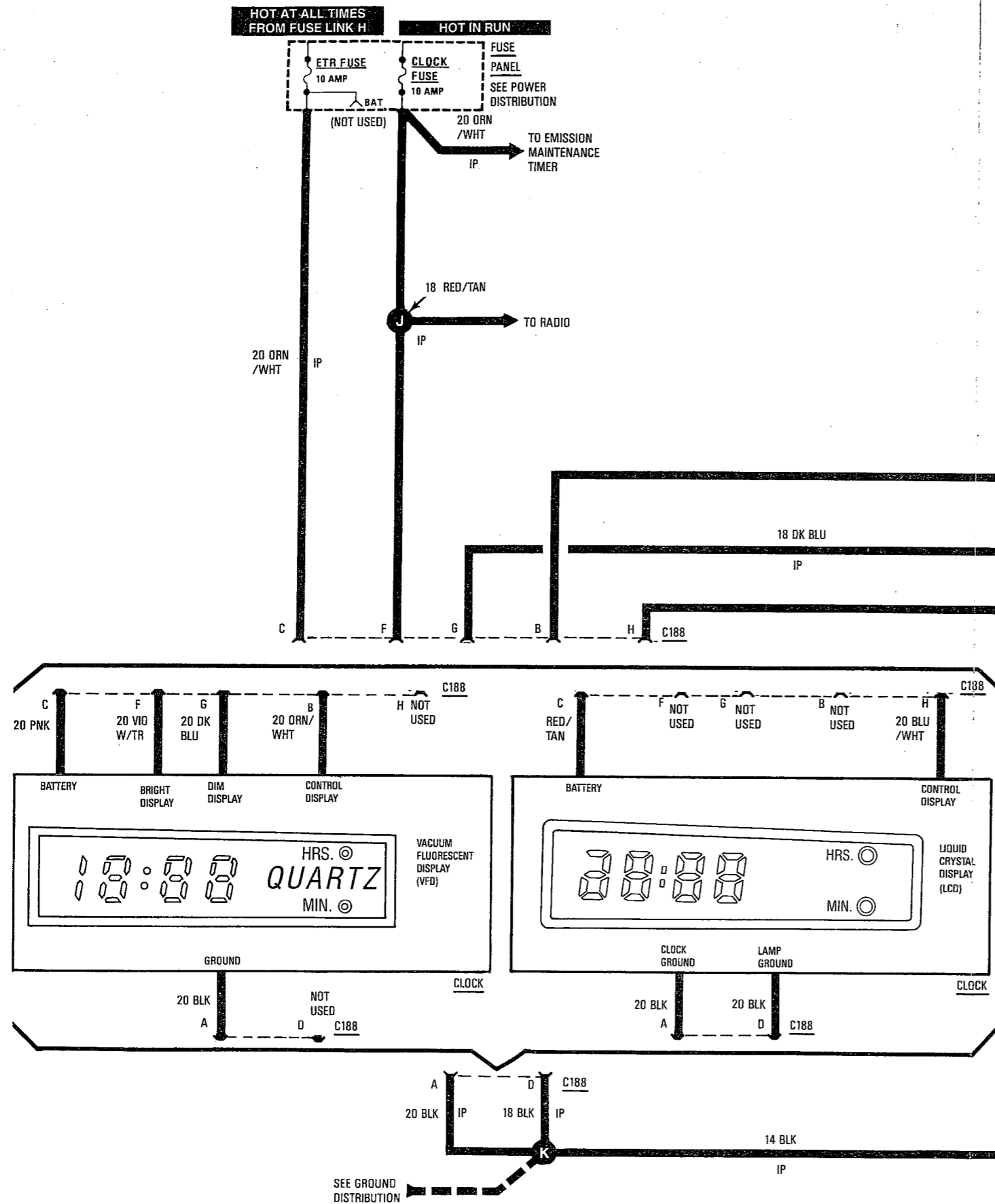

RADIO/CLOCK ILLUMINATION

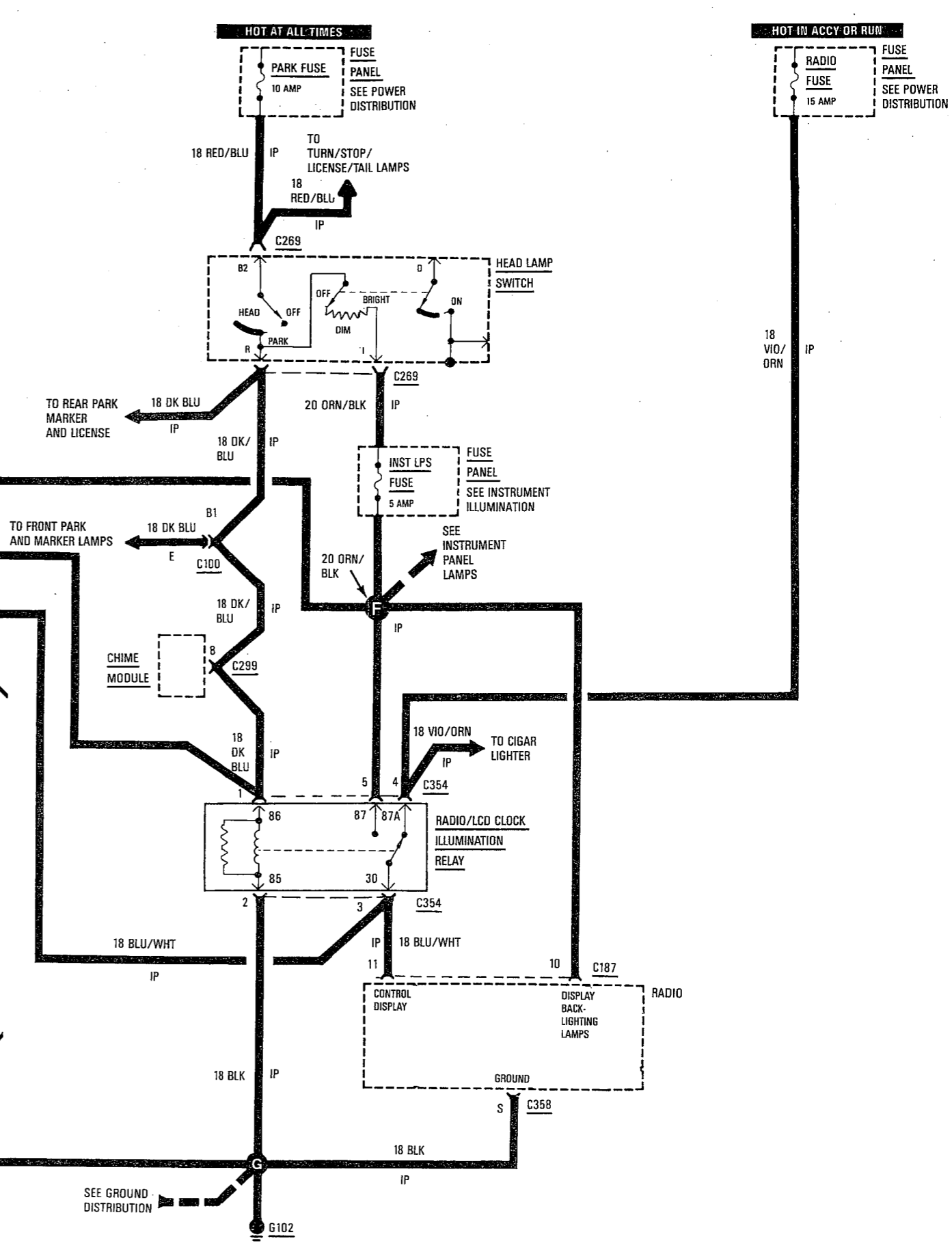

CLOCK — RADIO/CLOCK ILLUMINATION

DESCRIPTION

Two clocks options are available; a Vacuum Fluorescent Display (VFD) clock and a Liquid Crystal Display (LCD) clock. The harness connector is wired to accept either clock.

Vacuum Fluorescent Display (VFD) Clock

Battery power for clock memory is available at all times at C188 terminal C. Ground for the clock is connected at C188 terminal A.

With the ignition switch off, there is no display on the clock. Turning the ignition switch to RUN provides power to C188 terminal F, and the display lights.

Pulling the Headlamp Switch to PARK or HEAD provides power to C188 terminal 6. This input (DIM DISPLAY) switches control of the display brightness from the ignition switch (full brightness) to Instrument Panel Rheostat control (part of headlamp switch) at C188 terminal B. This allows variable control of the display brightness. There are no illumination bulbs in this clock. Lighting is provided by the VFD tubes.

Liquid Crystal Display (LCD) Clock

Battery power for the clock is available at all times at C188 terminal C. Ground for the clock is provided at C188 terminal

A. The LCD display for the current time of day is visible at all times.

Lighting for the display is controlled through the Radio/LCD Clock Illumination Relay. With the Headlamp Switch in OFF and the Ignition Switch in ACCY or RUN, power flows from the Radio Fuse, through the normally closed contacts of the Radio/LCD Clock Illumination relay to the clock and the display is at full brightness.

Pulling the Headlamp Switch to PARK or HEAD energizes the Radio/LCD Clock Illumination relay. This closes the normally open contacts of the relay and brightness for the clock display is now controlled by the Headlamp Switch rheostat at C188 terminal H.

Radio Illumination

With the Ignition Switch in ACCY or RUN, power flows from the Radio Fuse, through the normally closed contacts of the Radio/LCD Clock Illumination Relay to the Radio at C187 terminal 11.

Pulling the Headlamp Switch to PARK or HEAD energizes the Radio/LCD Clock Illumination Relay. This closes the normally open contacts of the relay, and the brightness for the radio display is controlled by the Headlamp Switch rheostat. The back-lighting for the radio is also controlled by the Headlamp rheostat through C187 terminal 10.

1. LIQUID CRYSTAL DISPLAY

Circuit Check: Clock Disconnected

TEST	OK	NOT OK
Connector C188 terminal C	Battery voltage	Repair open from ETR fuse
Connector C188 terminal A	Zero ohms	Repair open to G102

1. VFD CLOCK DISPLAY DOES NOT DIM WITH LIGHTS ON, RADIO DISPLAY OK

Circuit Check: Clock Disconnected, Ignition Switch ON, Lights ON, Dimmer Rheostat at Full Dim Position

TEST	OK	NOT OK
Connector C188 terminal G	Battery voltage	Repair open from headlamp switch
Connector C188 terminal B Rotate dimmer rheostat to full bright	From less than one volt to battery voltage If OK, replace clock	Repair open from splice F

1. LCD CLOCK DISPLAY AND/OR RADIO DISPLAY DO NOT DIM WITH LIGHTS ON

Circuit Check: Ignition in ACCY, Lights ON

TEST	OK	NOT OK
Connector C354 terminal 1	Battery voltage	Repair open from Headlamp Switch
Connector C354 terminal 2*	Zero ohms If OK, replace Radio/LCD Clock Illumination Relay	Repair open to G102
Connector C354 terminal 5	Battery voltage	Repair open from splice F
Connector C354 terminal 3	Battery voltage	Replace Radio/LCD Clock Illumination Relay
Clock Connector C188 terminal H and/or Radio Connector C187 terminal 11	Battery voltage If OK, replace clock and/or radio	Repair open from connector C354 terminal 3

* Lights Off

TROUBLESHOOTING

1. NO CLOCK DISPLAY VISIBLE/VACUUM FLUORESCENT DISPLAY

Circuit Check: Ignition in RUN, Clock Disconnected

TEST	OK	NOT OK
Connector C188 terminal F	Battery voltage	Repair open from clock fuse
Connector C188 terminal A	Zero ohms	Repair open to G102

INSTRUMENT PANEL LAMPS

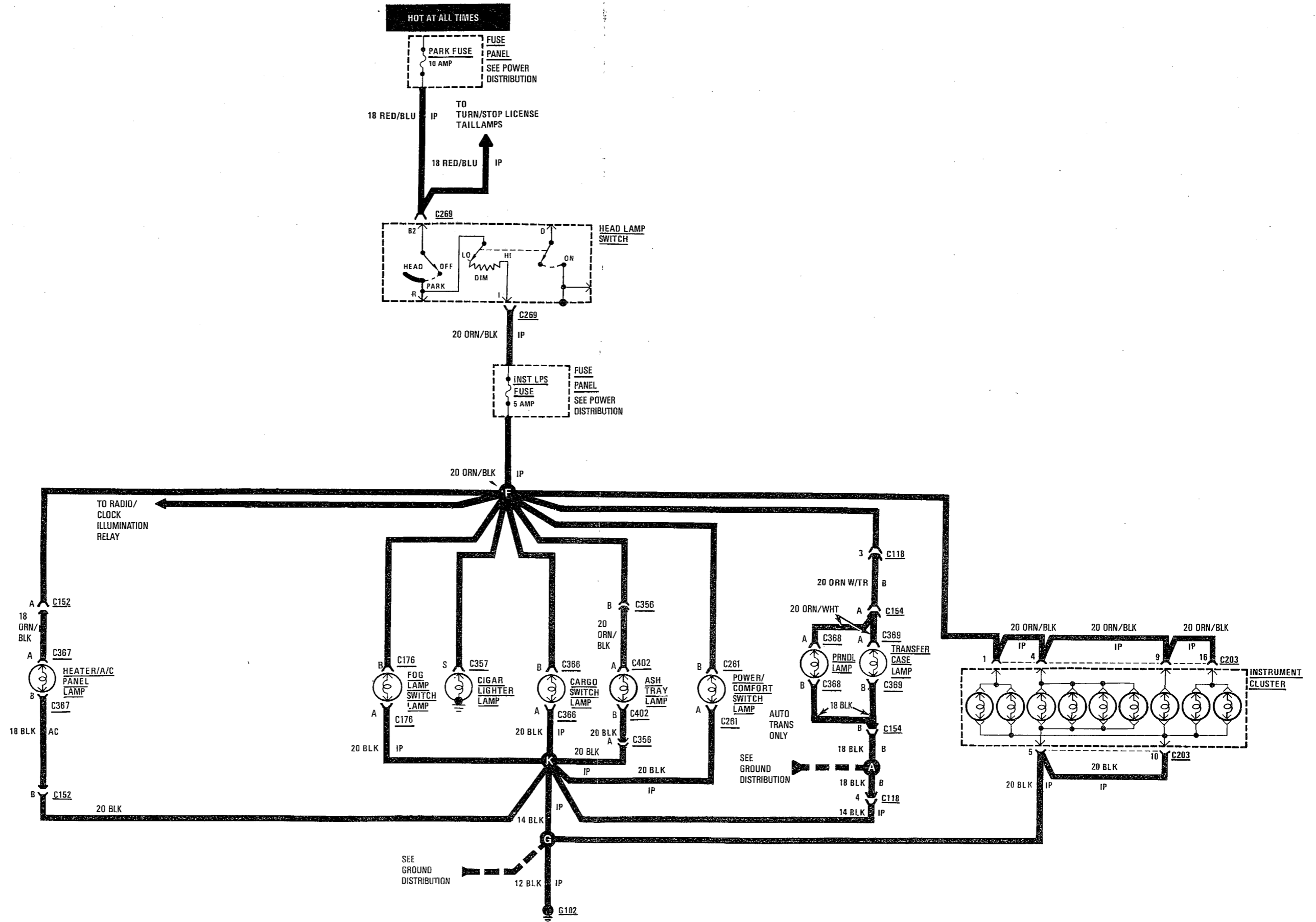

INSTRUMENT PANEL LAMPS

DESCRIPTION

Voltage is applied at all times through the park fuse to the headlamp switch. The circuit continues through the instrument lamps' fuse to the individual instrument panel lamps to ground. Lamp brightness is controlled by turning the headlamp switch knob.

TROUBLESHOOTING

1. INSTRUMENT PANEL LAMPS: ALL LAMPS INOPERATIVE

Parking lamps ON

TEST	OK	NOT OK
Park fuse	Not blown	Replace fuse
Inst. Lps. fuse	Not blown	Replace fuse
Battery side of Inst. Lps fuse*	Zero — Battery Voltage	Replace headlamp switch
Ground side of Inst. Lps fuse**	Almost zero ohms (bulb filaments)	Repair open to ground G102 If zero ohms ORN W/TR wire is shorted to ground, repair short

* Rheostat turned CCW to CW (LO to HI).

** Parking lamps OFF.

INTERIOR LAMPS

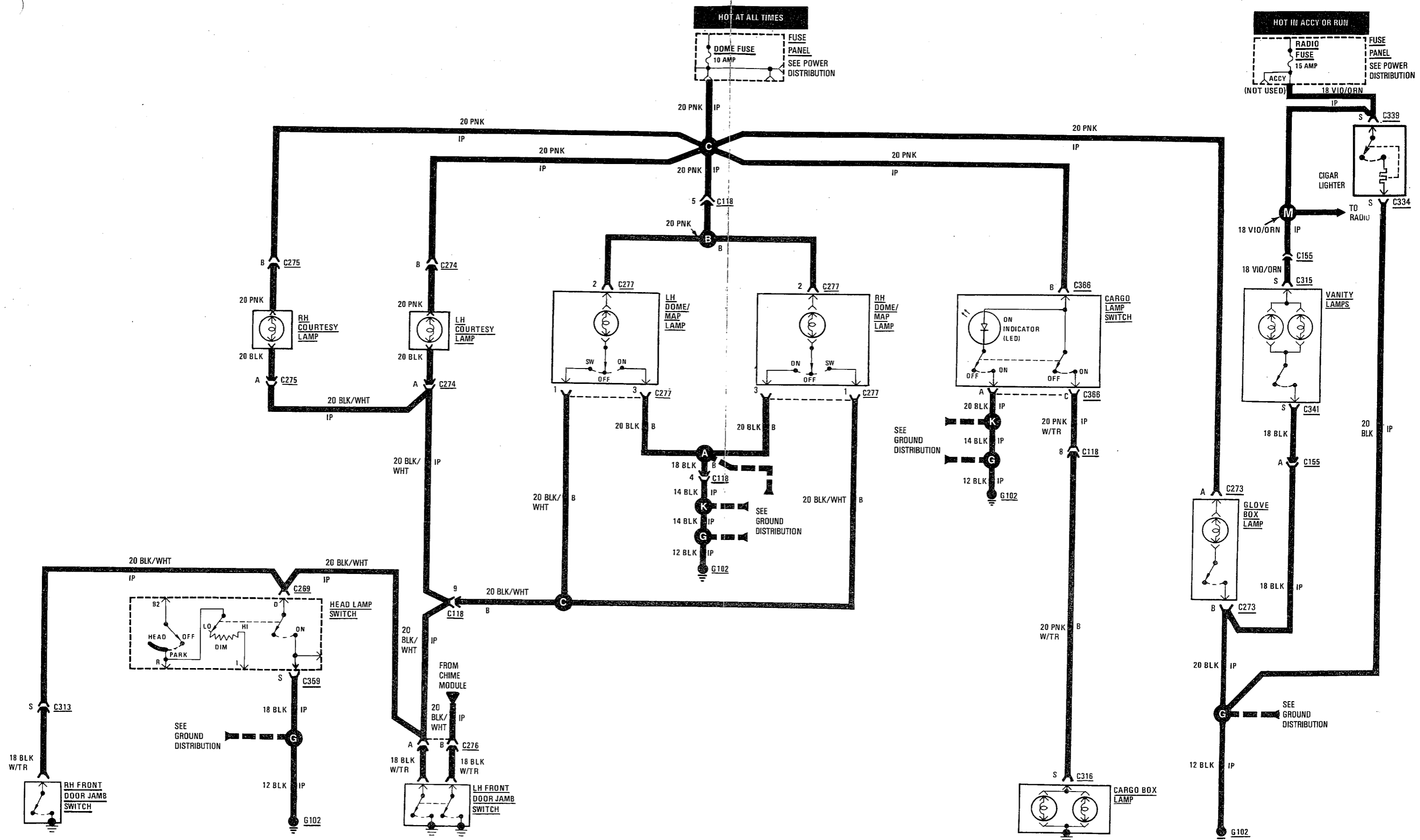

INTERIOR LAMPS

DESCRIPTION — GENERAL

Voltage is applied at all times through the dome fuse to each of the interior lamps. The courtesy, cargo, glove box and dome lamps operate when they are connected to ground through the headlamp switch, any door jamb switch, or the liftgate switch (if the cargo lamp switch is on.)

TROUBLESHOOTING

1. INTERIOR LAMPS: ALL LAMPS INOPERATIVE

Remove and inspect fuses

TEST	OK	NOT OK
Dome fuse	Not blown	Replace fuse
Radio fuse	Not blown	Replace fuse
Turn light switch on by rotating headlamp switch	Lamps light	Repair open to ground G102

1. INTERIOR LAMPS: ONE LAMP OUT

Lamp

TEST	OK	NOT OK
Across bulb terminals	Almost zero ohms (bulb filament)	Replace bulb
Battery side of bulb socket	Battery	Repair open to splice: C for courtesy lamps M for vanity lamps

1. INTERIOR LAMPS: INOPERATIVE WITH ONE OR MORE DOORS OPENED

Door Jamb Switches

TEST	OK	NOT OK
Remove switch in door that is inoperative and ground switch lead	Lamps light, replace switch	Repair open in BLK w/TR wire

DESCRIPTION — CIGAR LIGHTER AND VANITY LAMPS

Voltage is applied to the vanity lamps and cigar lighter through the radio fuse when the ignition switch is in ACCY or RUN. The vanity lamps operate when they are connected to ground through the vanity lamp switch. The cigar lighter element completes its circuit when pushed into the socket.

TROUBLESHOOTING

1. CIGAR LIGHTER INOPERATIVE

Perform steps 2 and 3 first; ignition in ACCY

TEST	OK	NOT OK
Push in lighter	Lighter pops out with a glowing hot element after a short wait	Replace lighter

1. VANITY LAMPS INOPERATIVE

Perform steps 2 and 3 first; ignition in ACCY, switch ON

TEST	OK	NOT OK
C315 terminal S	Battery voltage	Repair open to splice M
C341 terminal S	Zero ohms	Repair open to splice K
Across C315 and C344	Almost zero ohms (bulb filament)	Replace bulbs If still inoperative replace vanity

2. POWER INPUT

Remove and inspect fuse

TEST	OK	NOT OK
Radio fuse	Not blown	Replace fuse

3. GROUND

Remove cigar lighter

TEST	OK	NOT OK
Side of cigar lighter to ground	Zero ohms	Repair open to G102

INTERIOR LAMPS

DESCRIPTION — CARGO BOX LAMPS

The cargo lamps receive power from the dome fuse. Power is controlled by the cargo lamp switch. The switch indicator lights whenever the switch is turned on.

TROUBLESHOOTING

1. INDICATOR (LED) IS OFF

Switch in ON, switch connected

TEST	OK	NOT OK
Open door	Courtesy lamps light	Replace Dome fuse
C336 terminal B*	Battery voltage	Repair open to splice C
C336 terminal C	Battery voltage	Replace switch
C336 terminal A**	Zero ohms	Repair open to splice K
Across C336 terminal A to B flip test leads**	Almost zero ohms /infinity (open)	Replace switch

* Remove switch and re-connect under I.P.

** Unplug switch.

HEADLAMPS AND FOGLAMPS

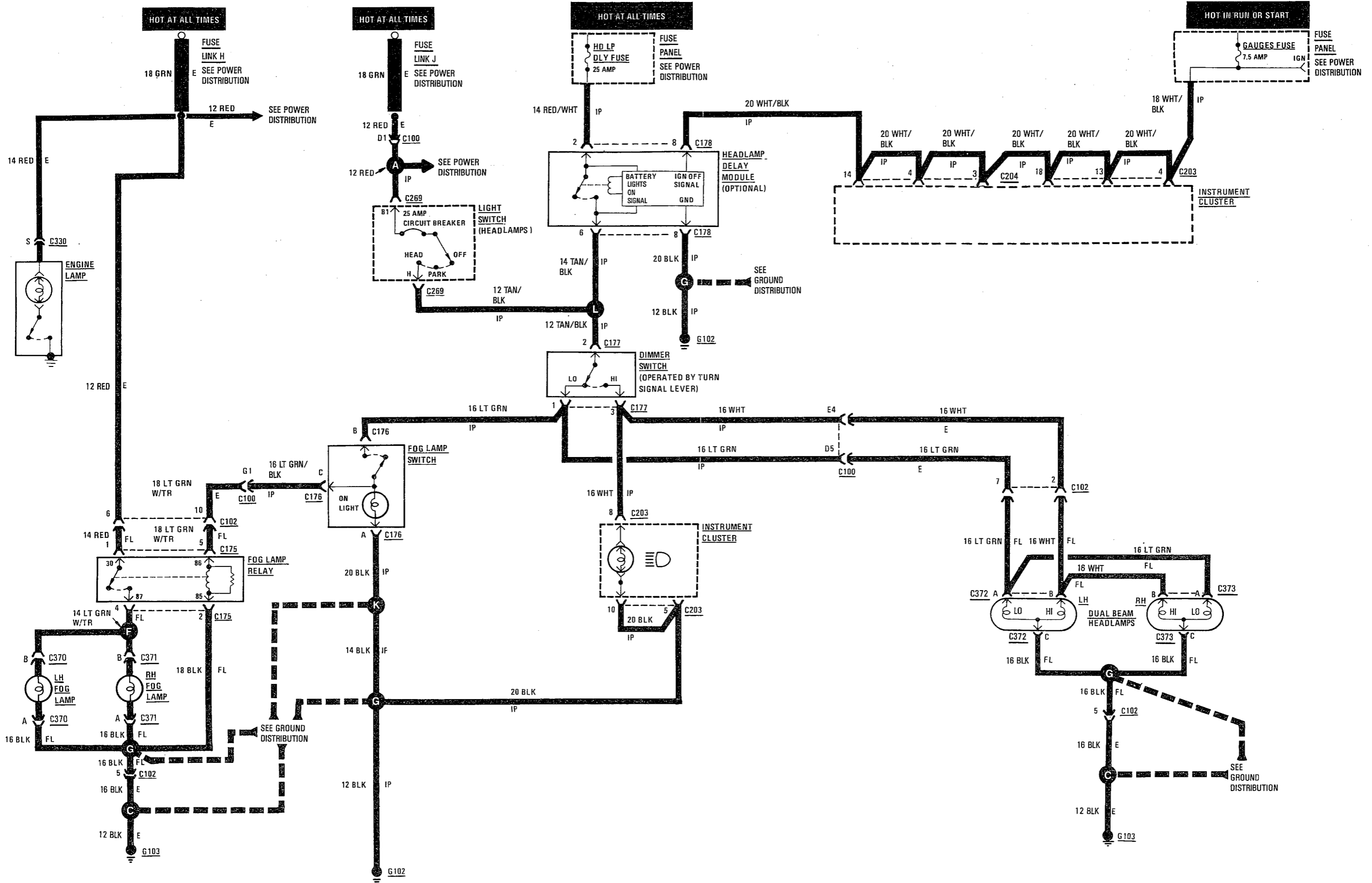

HEADLAMPS AND FOGLAMPS

DESCRIPTION — HEADLAMPS

Voltage is applied to the light switch at all times from Fuse Link J. The light switch includes a self-resetting circuit breaker. The circuit breaker opens when the headlamp circuit draws too much current. With no current flow, the circuit breaker cools off and resets automatically. Do not allow the resetting condition to continue. Make necessary repairs.

When the light switch is in HEAD, the headlamp dimmer switch directs voltage to either the LO beams or the HI beams. The HI beam indicator also receives voltage the same time as the HI beams.

TROUBLESHOOTING

1. ALL LO AND HI HEADLAMPS FILAMENTS — INOPERATIVE

Light Switch in HEAD

TEST	OK	NOT OK
Check operation of Fuse Link J components, see power distribution	Components are functional	Check for blown fuse link If blown go to Step 2
Back probe C102 terminal 5	Zero ohms	Repair open to G103
Front Lamp Harness side, C102 disconnect terminal 5 to 2 then 5 to 7	Almost zero ohms (bulb filament)	Replace Headlamps
C177 terminal 2	Battery voltage	Next step
C177 terminal 2*	Infinite Resistance If OK, replace Light Switch and go to next step	Repair short in TAN/BLK wire circuit
C177 terminal 1	Almost zero ohms (bulb filaments) If OK, go to next step	Repair short in LT GRN wire circuit
C177 terminal 3	Almost zero ohms (bulb filaments) If OK, test dimmer switch and connect C177	Repair short in WHT wire circuit

* Light Switch in OFF, C177 unplugged

2. FUSE LINK J — BLOWN

Disconnect Negative Battery Cable, cut Fuse Link from Red wire

TEST	OK	NOT OK
Red wire to ground*	Infinite Resistance If OK, replace fuse link	Repair short in RED wire circuit

* All Switchs OFF

1. ALL LO OR HI BEAMS — INOPERATIVE

Light Switch in OFF, C177 unplugged

TEST	OK	NOT OK
C177 terminal 1	Almost zero ohms (bulb filament)	Repair open to Headlamps
C177 terminal 3	Almost zero ohms (bulb filament) If OK, replace dimmer switch	Repair open to Headlamps

DESCRIPTION — FOG LAMPS

With the dimmer switch in LO, voltage is applied to the fog lamp switch. If the switch is closed, current flows through the ON light to ground and through the coil of the fog lamp relay to ground. The relay energizes, pulling the contacts closed. Current flows from fuse link H through the relay contacts and fog lamps to ground.

HEADLAMPS AND FOGLAMPS

TROUBLESHOOTING

1. FOG LAMPS — INOPERATIVE

Fog Lamp Relay unplugged, Light Switch in HEAD, Dimmer Switch in LO, Fog Lamp Switch in ON

TEST	OK	NOT OK
C175 terminal 2	Zero ohms	Repair open to Splice C
C175 terminal 1	Battery voltage	Repair open to Fuse Link H
C175 terminal 5	Battery voltage	Repair open through Fog Lamp Switch to C177 terminal 1,
Jumper fused test leads C175 terminal 1 to 4	Lamps lights If OK, replace relay	Repair open through Fog Lamps to Splice G

DESCRIPTION — HEADLAMP DELAY MODULE

The headlamp delay module provides power to the headlamps for about 45 seconds after the ignition is turned off. The driver activates the module by turning the ignition OFF, then turning the headlamps OFF. When the module

loses voltage at the ign OFF signal (from Gauges Fuse) and then at the lights ON signal, it activates the relay, pulling the contact closed. Current flows from the hd lp/dly fuse through the headlamp delay module, the dimmer switch and the RH and LH headlamps. After 45 seconds, the headlamp delay module de-activates and the headlamps turn OFF.

TROUBLESHOOTING

1. POWER INPUT AND GROUND

Remove and inspect fuse

TEST	OK	NOT OK
HD LP Fuse	Not blown	Replace fuse
Side of cigar lighter socket to ground	Zero ohms	Repair open to G102

2. HEADLAMP DELAY MODULE

Remove module, Ignition in RUN, Light Switch in HEAD

TEST	OK	NOT OK
C178 terminal 4	Zero ohms	Repair open to Splice G
C178 terminal 8	Battery voltage	Repair open to C203 terminal 14
C178 terminal 6	Battery voltage	Repair open to Splice L
C178 terminal 2	Battery voltage	Repair open to fuse

LAMPS: SIDE MARKER/PARK/TAIL/LICENSE

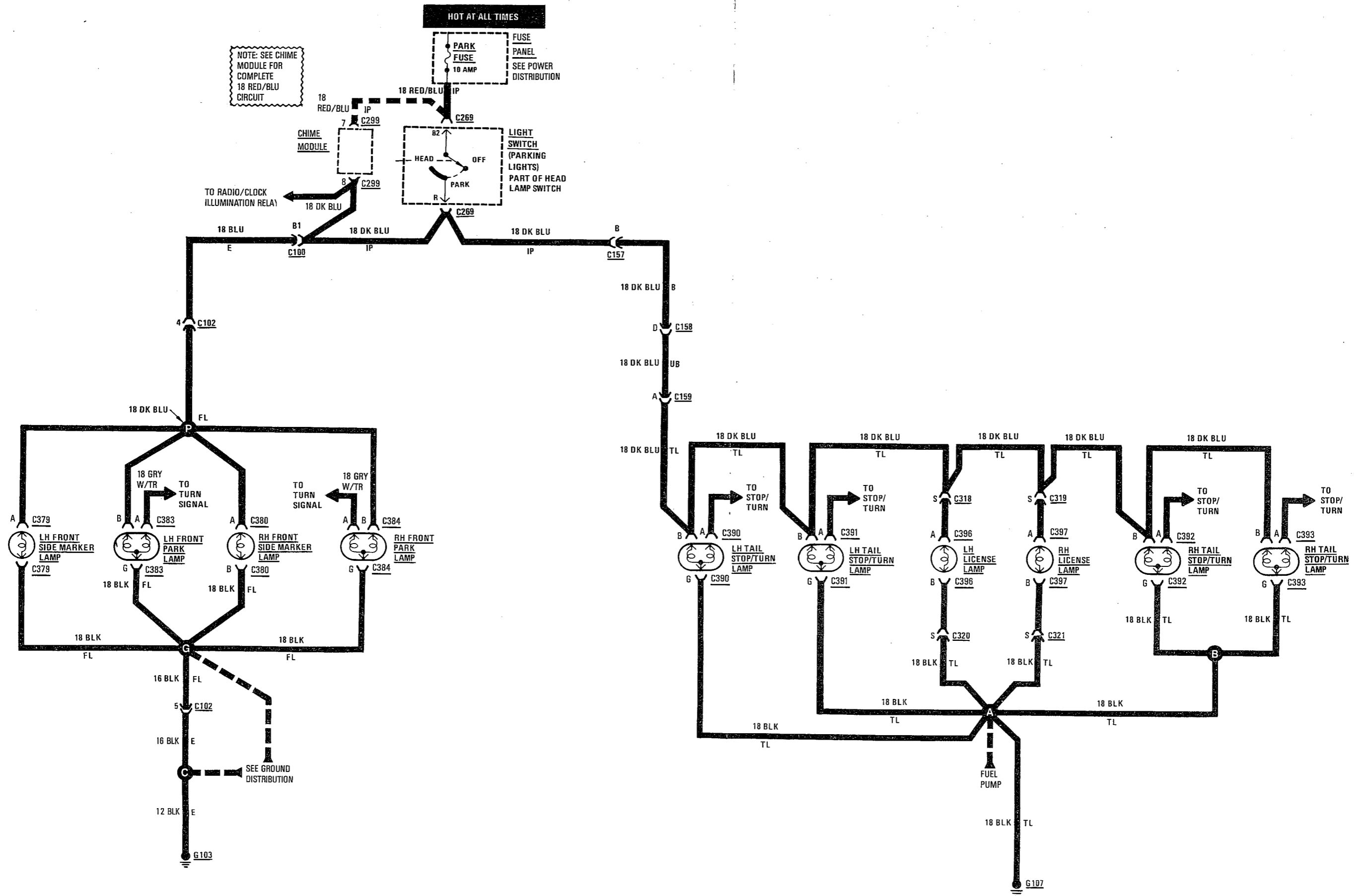

LAMPS: SIDE MARKER/PARK/TAIL/LICENSE

DESCRIPTION

With the light switch in PARK or HEAD, battery voltage is applied through the light switch contacts to the park, side marker, tail, and license lamps and to their respective grounds.

TROUBLESHOOTING

1. ALL PARKING LAMPS INOPERATIVE

Light Switch in ON, Chime Module Removed, Key in Ignition Switch

TEST	OK	NOT OK
C299 terminal 7	Battery voltage	Replace fuse*
C299 terminal B	Battery voltage	Go to next step
C269 terminal R	Battery voltage If OK, repair open between connector C269 terminal R and connectors C100-B1 and C157-B	Replace light switch

* If fuse blows again, check DK BLU circuit for short to ground.

2. FRONT PARKING LAMPS INOPERATIVE

Light Switch OFF, back probe C102

TEST	OK	NOT OK
C102 terminal 5	Zero ohms	Repair open to Splice C
C102 terminal 4*	Battery voltage	Repair open to C269 terminal R
Across C102 terminals 4 and 5**	Almost zero ohms (bulb filaments)	Repair open

* Light Switch in ON

** C102 unplugged, make check on Front Lighting Harness side of connector C102.

3. REAR PARKING LAMPS INOPERATIVE

Light Switch OFF

TEST	OK	NOT OK
Any rear lamp BLK wire to ground	Zero ohms	Repair open to G107
C159 terminal A	Battery voltage	Repair open to C269 terminal R

LAMPS: TURN/STOP/BACKUP

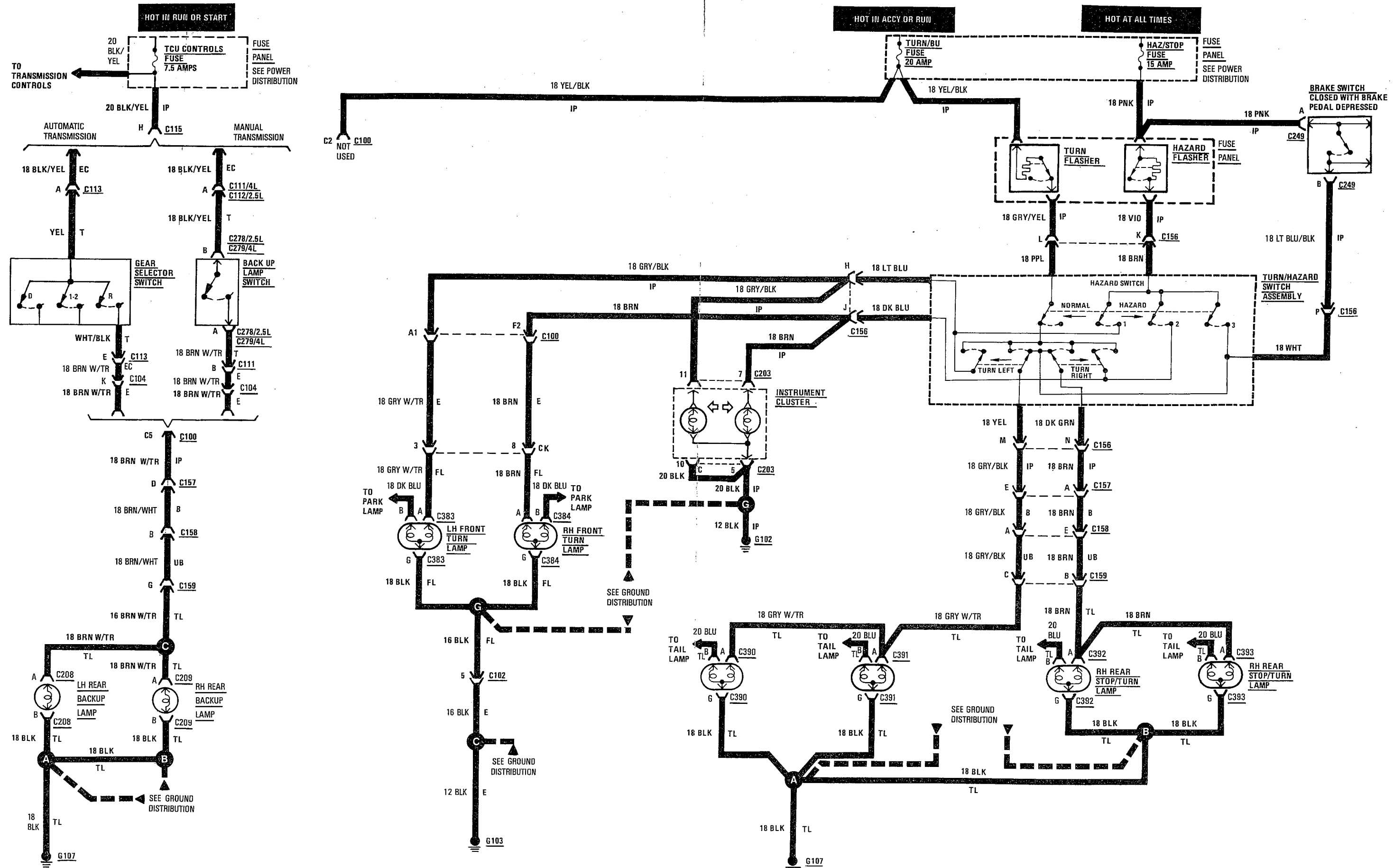

LAMPS: TURN/STOP/BACKUP

DESCRIPTION — GENERAL

The haz/stop fuse applies voltage to the hazard flasher and the brake switch at all times. The Turn/bu fuse applies voltage to the turn flasher when the ignition switch is in ACCY or RUN.

The tcu fuse powers the backup lamps through the REVERSE position switch contacts when the transmission is in REVERSE.

DESCRIPTION — TURN SIGNALS

With the multi-function lever in its UP or DOWN position, current flows through the normally closed turn signal flasher contact, the turn/hazard switch assembly, the select

turn indicator and the front and rear bulbs to ground. The lamps go on immediately. They begin to flash when voltage is applied to the flasher causing the contacts to open and close the selected circuit.

TROUBLESHOOTING

NOTE: High Alternator output voltage can burn out Lamps rapidly.

1. ALL TURN SIGNAL LAMPS — INOPERATIVE

Remove and inspect fuse, Ignition in ACCY, LH Turn Switch in ON, Hazard Switch pulled OUT

TEST	OK	NOT OK
Turn/Bu Fuse	Not blown	Replace fuse
Fuse side of Turn Flasher	Battery voltage	Repair open to fuse
Replace Turn Flasher with 3 Lamp 12 volt rating Flasher	Lamps flash	Next step
C156 terminal L	Battery voltage If OK, replace Turn/Hazard Switch Assembly	Repair open to Turn Flasher

DESCRIPTION — HAZARD LAMPS

With the hazard switch in its OUT position, current flow heads up the timing element in the hazard flasher, causing the flasher contacts to close and open repeatedly. When the hazard/flasher contacts are closed, current flows through

hazard switches 1 and 2, both indicator bulbs, and both front turn signal bulbs to ground. Current also flows through hazard switch 3, and both rear turn signal bulbs to ground. All of the turn lamps and both turn indicators flash on and off.

TROUBLESHOOTING

1. ALL HAZARD LAMPS — INOPERATIVE

Hazard Switch in ON

TEST	OK	NOT OK
Depress Brake Pedal	Stop Lamps light	Replace Haz/Stop fuse
Fuse side of Hazard Flasher	Battery voltage	Repair open to fuse
Replace Hazard Flasher	Lamps flash	Next step
C156 terminal K	Battery voltage If OK, replace Turn/Hazard Switch Assembly	Repair open to Hazard Flasher

DESCRIPTION — BRAKE LAMPS

The brake switch closes when the brake pedal is depressed. With the brake switch closed, current flows through the right and left stop lamps to ground.

TROUBLESHOOTING

1. ALL BRAKE LAMPS — INOPERATIVE

Turn Signal Switch in NORMAL position

TEST	OK	NOT OK
Push in Hazard Switch	Lamps flash	Replace Haz/Stop Fuse
C249 terminal A	Battery voltage	Repair open to fuse
C249 terminal B*	Battery voltage	Replace Brake Switch
C156 terminal P*	Battery voltage	Repair open to Brake Switch
C156 terminal N*	Battery voltage	Replace Turn/Hazard Switch Assembly
C156 terminal N, then terminal M	Almost zero ohms (bulb filaments)	Check lamps
BLK wire at bulb socket	Zero ohms	Repair open to G107
GRY W/TR or BRN wire at bulb socket*	Battery voltage	Repair open to Turn/Hazard Switch

* Brake Pedal depressed

LAMPS: TURN/STOP/BACKUP

DESCRIPTION — BACKUP LAMPS

The backup switch closes when the transmission is in reverse. With the backup switch closed, current flows through the left and right backup lamps to ground.

TROUBLESHOOTING

1. ALL BACKUP LAMPS — INOPERATIVE

Remove and inspect fuse, Parking Brake ON, Trans in REVERSE, Ignition in RUN

TEST	OK	NOT OK
TCU Fuse	Not blown	Replace fuse
Fuse side of switch	Battery voltage	Repair open to fuse
Across switch	Zero ohms	Replace switch
Lamp side of switch	Almost zero ohms (bulb filaments)	Check Lamps If OK, repair open between Lamps and switch

DIAGNOSTIC/CONNECTORS

DIAGNOSTIC CONNECTOR — D1

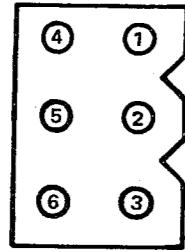

2.5L ENGINE—D1

CAVITY	WIRE COLOR	COMPONENT CONNECTED
1	GRN W/TR	TACHOMETER
2	YEL	IGNITION SWITCH
3	BLK	ECU GROUND
4	GRN W/TR	STARTER SOLENOID
5	RED	BATTERY
6	ORN	FUEL PUMP RELAY

4L ENGINE—D1

CAVITY	WIRE COLOR	COMPONENT CONNECTED
1	GRN W/TR	TACHOMETER
2		NOT USED
3	BLK	ECU GROUND
4		NOT USED
5	RED	BATTERY
6	ORN	FUEL PUMP RELAY

DIAGNOSTIC CONNECTOR — D2

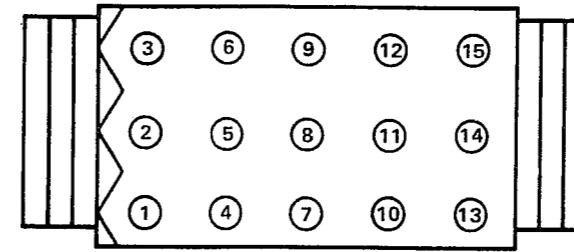

2.5L ENGINE D-2

CAVITY	WIRE COLOR	COMPONENT CONNECTED
1	PNK W/TR	UPSHIFT LAMP (MANUAL) ECU SERIAL DATA (AUTO)
2	BLK W/TR	B + LATCH RELAY (COIL GROUND)
3	BLK W/TR	PARK/NEUTRAL (AUTO) ECU SERIAL DATA (MANUAL)
4	PNK	B + LATCH RELAY (COIL FEED)
5	ORN	A/C CLUTCH RELAY
6	BLU/ORN	POWER STEERING PRES. SW
7	BLK	SYSTEM GROUND
8	TAN W/TR	AIR TEMPERATURE SENSOR
9	ORN W/TR	IGNITION CONTROL MODULE (TIMING)
10	GRN	EGR CANISTER PURGE SOLENOID
11	LT GRN	IDLE SPEED MOTOR (EXTEND)
12	TAN	COOLANT TEMPERATURE SENSOR
13	GRY W/TR	IDLE SPEED CONTROL MOTOR (CLOSED THROTTLE SWITCH)
14	GRN	IDLE SPEED MOTOR (RETRACT)
15	YEL W/TR	AUTO TRANS DIAGNOSIS

4L ENGINE—D2

CAVITY	WIRE COLOR	COMPONENT CONNECTED
1	BRN/PNK	ECU (TX SERIAL DATA OUTPUT)
2	BLK/WHT	ECU (RX SERIAL DATA INPUT)
3	BLK	B + LATCH RELAY (COIL GROUND)
4	YEL	IGNITION SWITCH
5	PNK	B + LATCH RELAY (COIL FEED)
6	ORN/BRN	A/C CLUTCH RELAY
7	BLK	IGNITION CONTROL MODULE GROUND
8	BRN W/TR	MAP SENSOR GROUND
9	ORN	OXYGEN HEATER RELAY
10		NOT USED
11	PNK W/TR	UPSHIFT LAMP (MANUAL TRANS)
12		NOT USED
13		NOT USED
14		NOT USED
15	YEL W/TR	AUTO TRANS DIAGNOSIS

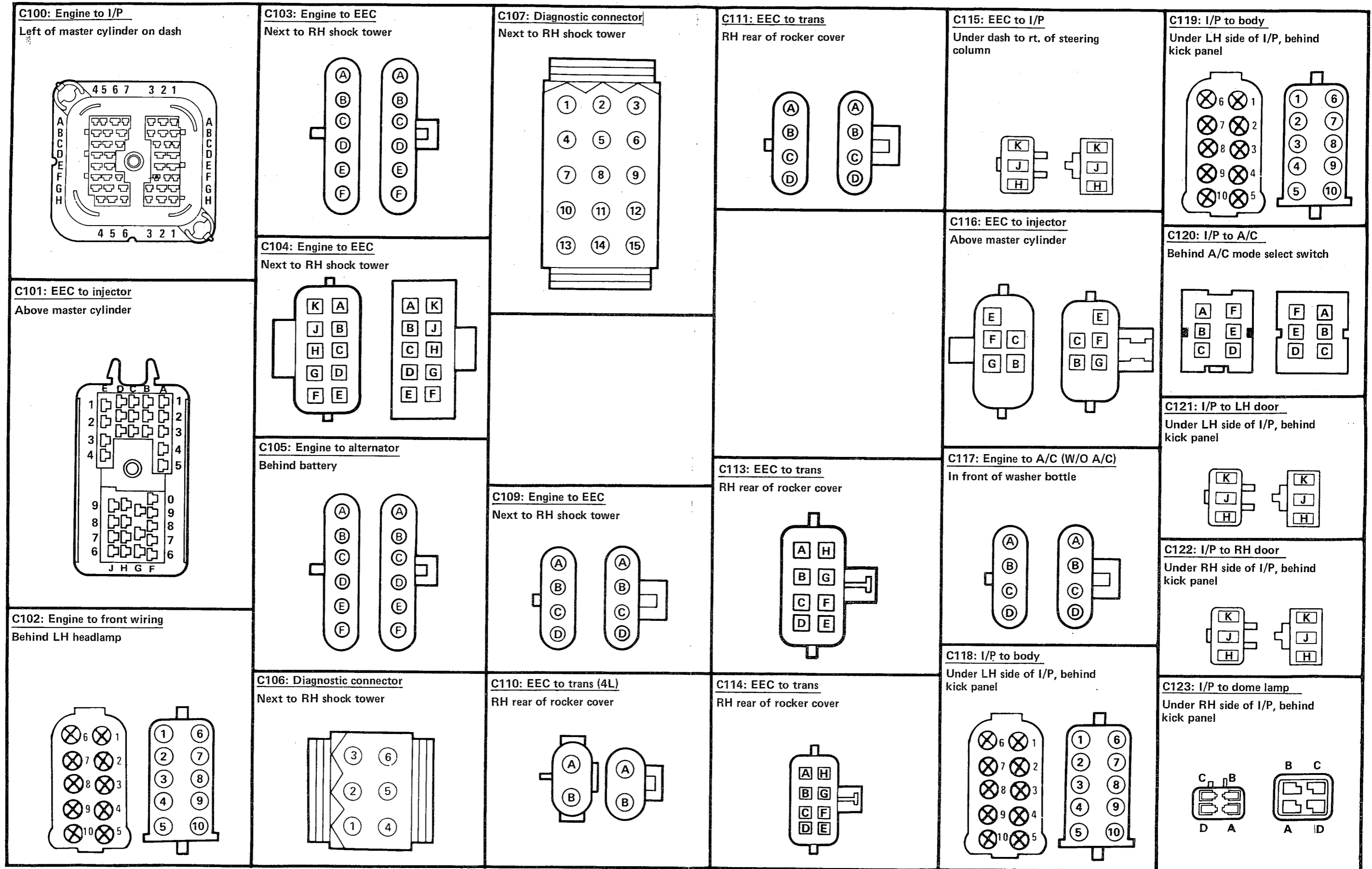

CONNECTOR VIEWS

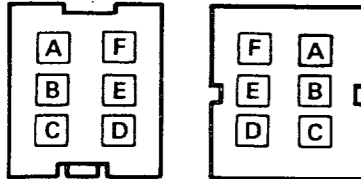
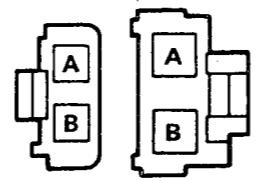
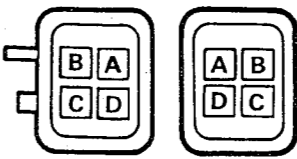
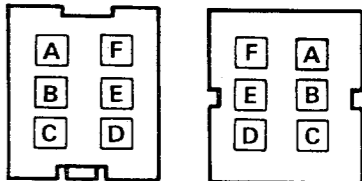
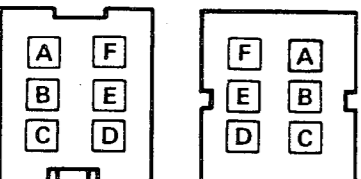
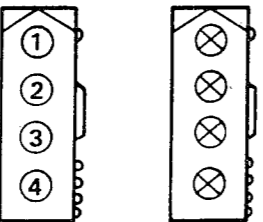
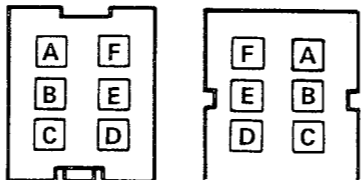
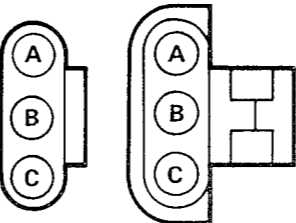
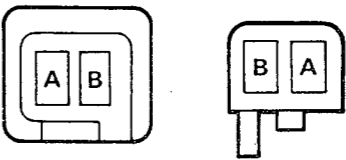
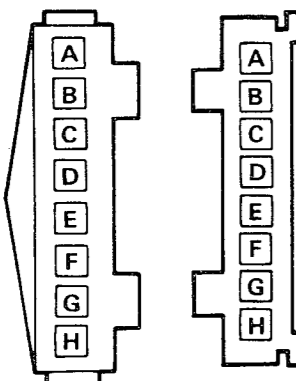
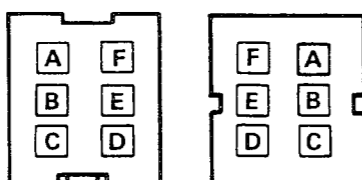
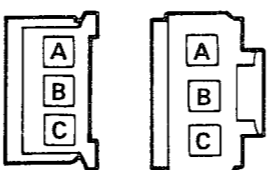
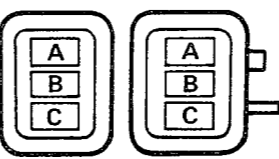
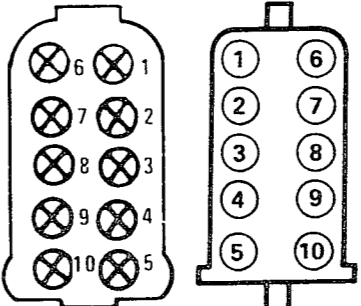
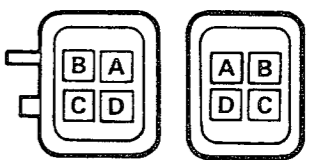
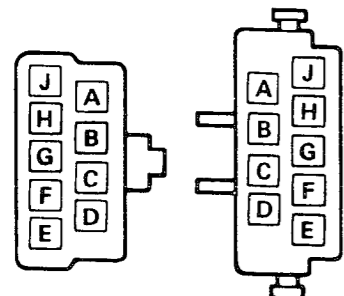
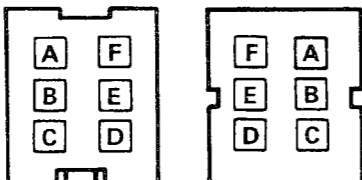
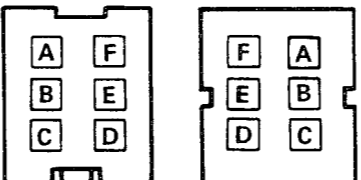
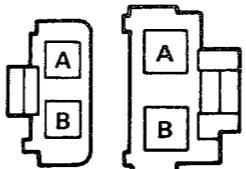
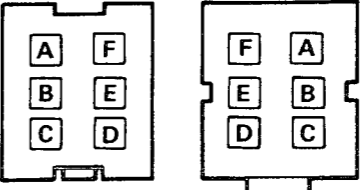
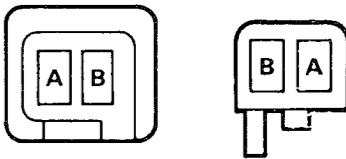
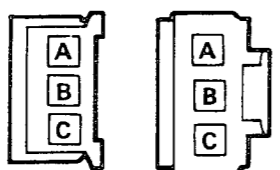
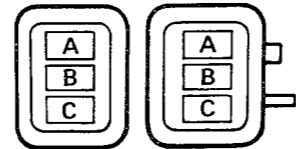
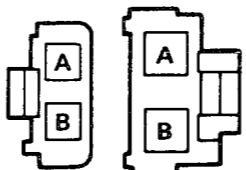
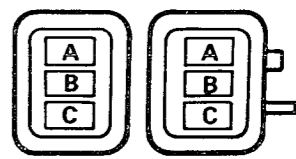

CONNECTOR VIEWS

<p>C124: Body to crossbody Under LH side of I/P, behind kick panel</p> 			<p>C138: Body to seats Under front seat</p> 	<p>C143: Body to liftgate Behind LH rear inner fender panel</p> 	<p>C147: Rear crossbody to tail lamp Behind RH rear inner fender panel</p> 
<p>C125: Body to LH rear door Behind RH kick panel</p> 	<p>C129: I/P to dome lamp Under RH side of I/P, behind kick panel</p> 	<p>C134: Crossbody to RH door Under RH side of I/P at kick panel</p> 	<p>C139: Body to fuel tank LH rear inner fender panel</p> 	<p>C144: Body to liftgate Behind LH rear inner fender panel</p> 	
<p>C126: Body to trailer relay Behind LH rear inner fender panel</p> 	<p>C130: Crossbody to LH door Under LH side of I/P at kick panel</p> 	<p>C135: Crossbody to RH door Under RH side of I/P at kick panel</p> 	<p>C140: Body to liftgate Behind LH rear inner fender panel</p> 	<p>C145: Body to rear crossbody Behind LH rear inner fender panel</p> 	<p>C149: Liftgate to liftgate In LH side of liftgate</p> 
<p>C127: Trailer relay to trailer tow Behind LH rear inner fender panel</p> 	<p>C131: Crossbody to LH door Under LH side of I/P at kick panel</p> 	<p>C136: Crossbody to RH rear door Under RH side of I/P at kick panel</p> 	<p>C141: Body to liftgate Behind LH rear inner fender panel</p> 	<p>C146: Body to tail lamp Behind LH rear inner fender panel</p> 	<p>C150: Liftgate to liftgate In LH side of liftgate</p> 
	<p>C132: Crossbody to LH door Under LH side of I/P at kick panel</p> 	<p>C137: Crossbody to RH door Under RH side of I/P at kick panel</p> 	<p>C142: Body to liftgate Behind LH rear inner fender panel</p> 		<p>C151: Liftgate to liftgate In LH side of liftgate</p> 

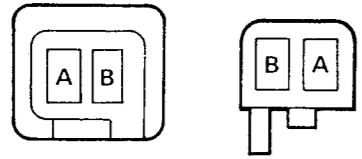
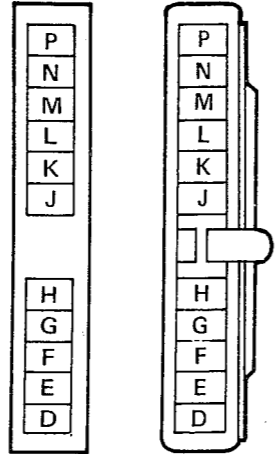
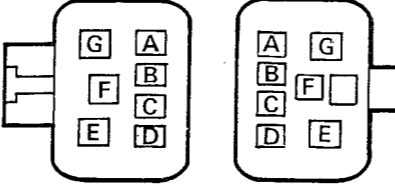
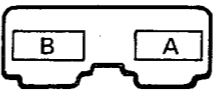
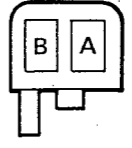
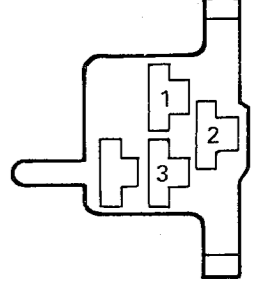
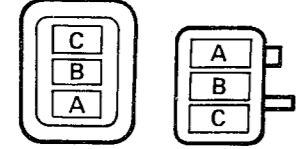
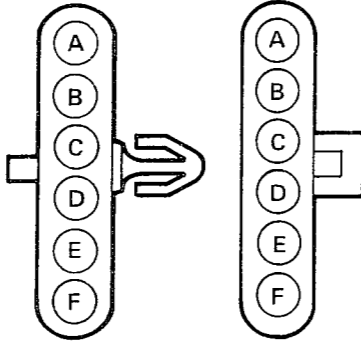
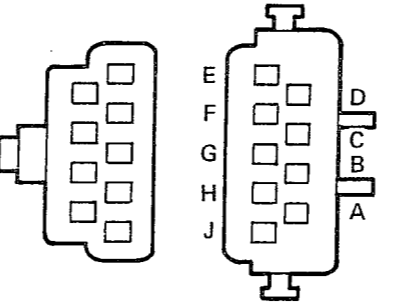
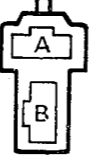
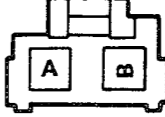
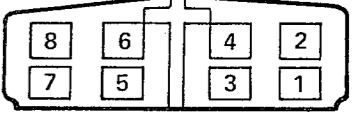
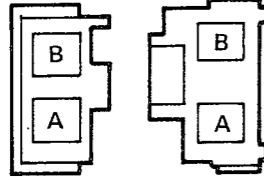
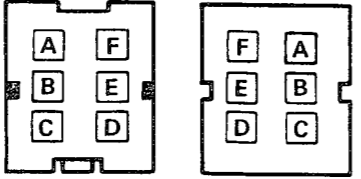
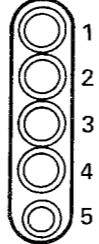
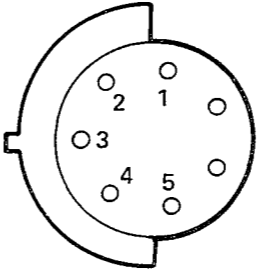
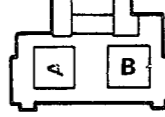
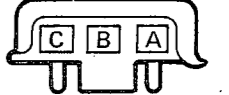
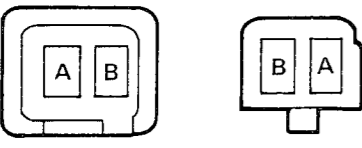
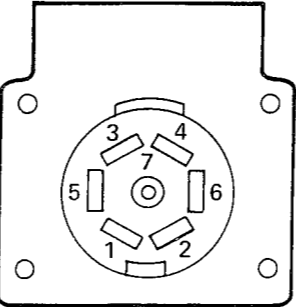
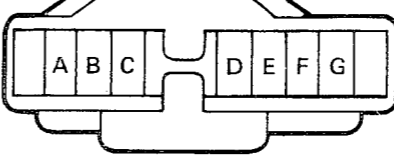
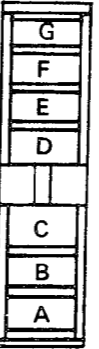
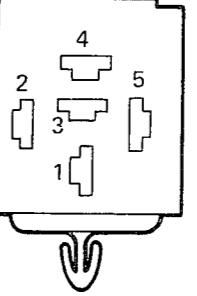
CONNECTOR VIEWS

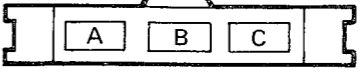
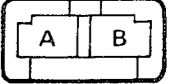
<p>C152: I/P to A/C Behind A/C mode switch</p> 	<p>C156: I/P to turn signal Under I/P on steering column</p> 	<p>C159: Underbody to tail lamp Behind LH rear tail lamp assembly</p> 	<p>C168: Washer fluid level Top of washer bottle (if equipped)</p> 	<p>C172: Seatbelt switch In driver's seatbelt buckle</p> 	<p>C177: Headlamp dimmer switch LH side of I/P next to light switch</p> 
<p>C153: Rear crossbody to cargo lamp Near cargo lamp</p> 	<p>C157: I/P to cab Below LH side of I/P above parking brake</p> 	<p>C160: Trailer relay to trailer tow Behind LH rear inner fender panel</p> 	<p>C169: Washer pump Below washer bottle</p> 	<p>C173: RH power seat Under RH front seat</p> 	<p>C178: Headlamp delay module LH side of I/P next to light switch</p> 
<p>C154: Trans lamp jumper Above transfer case</p> 	<p>C158: Cab to underbody Rear center of cab under carpet</p> 	<p>C161: Trailer tow At rear bumper</p> 	<p>C170: Wiper motor LH side of cowl panel grill</p> 	<p>C174: LH power seat Under LH front seat</p> 	<p>C179: Power antenna relay Behind RH side of I/P</p> 
<p>C155: I/P to vanity lamp Behind RH kick panel</p> 	<p>C162: Trailer tow At rear bumper</p> 	<p>C171: Wiper switch To lt. of steering column</p> 	<p>C171A</p> 	<p>C175: Fog lamp relay Behind RH headlamp</p> 	<p>C180: LH door speaker Located at speaker</p> 
<p>C176: Fog lamp switch On lt. of steering column</p> 	<p>C181: LH I/P speaker Located at speaker</p> 				



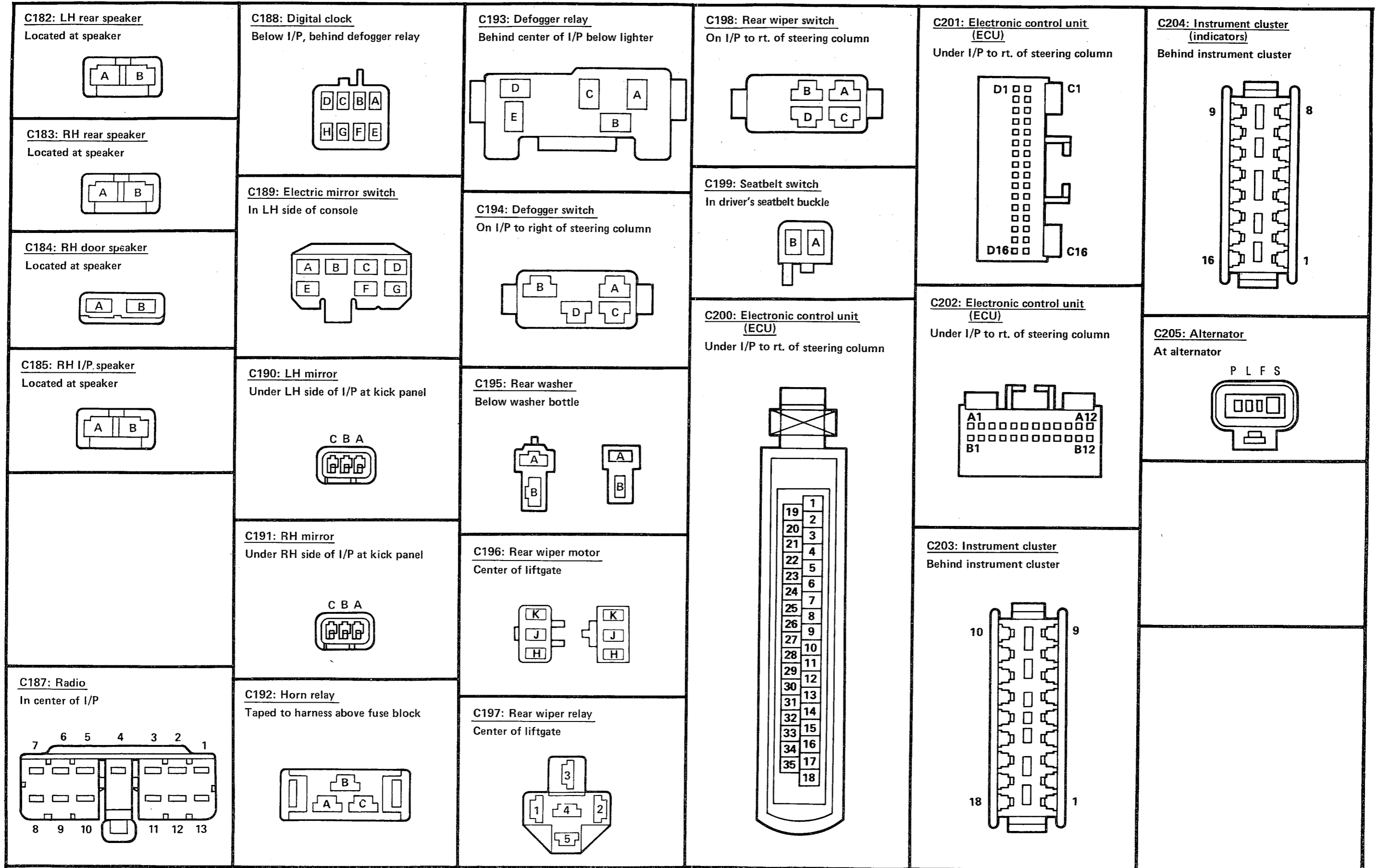

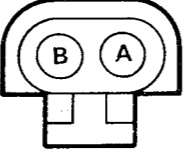
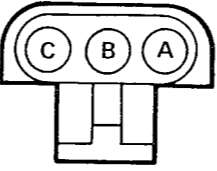
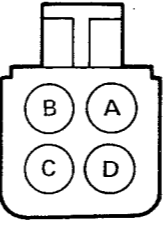
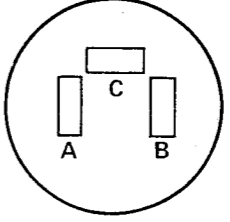
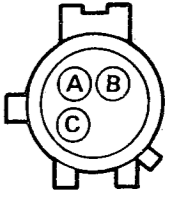
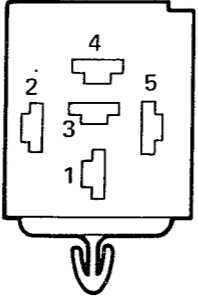
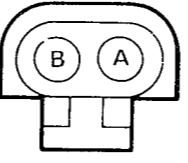
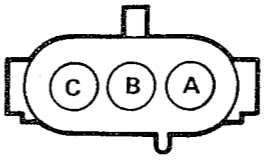
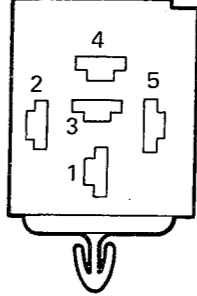
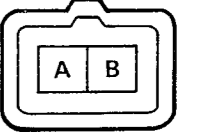
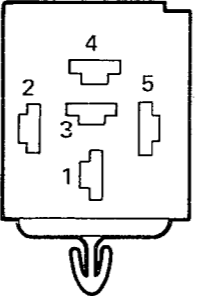
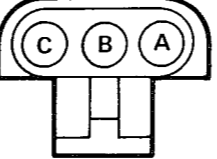
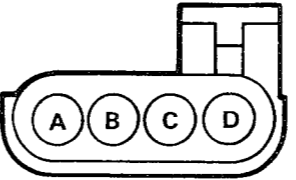
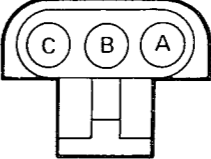
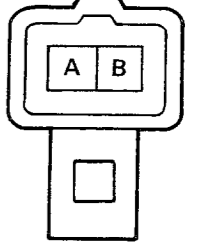
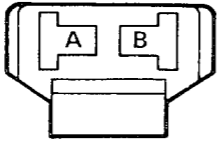
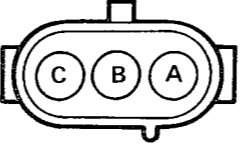
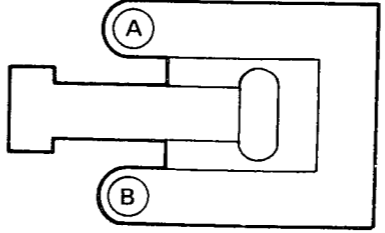
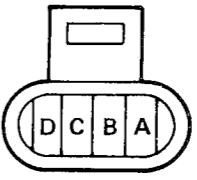
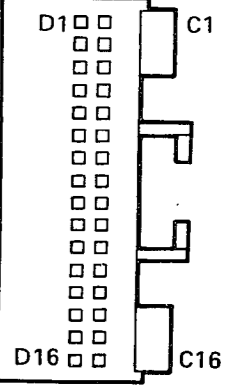
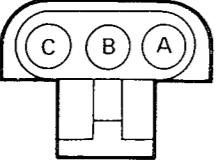
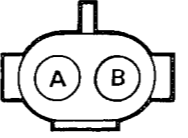

CONNECTOR VIEWS



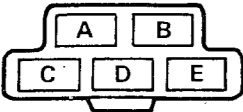
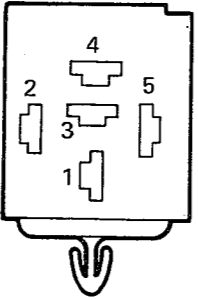
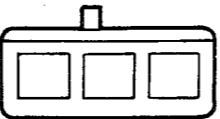
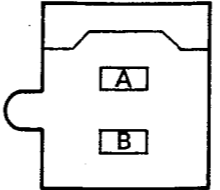
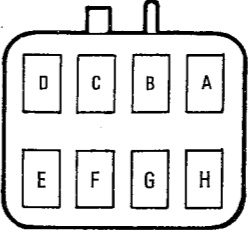
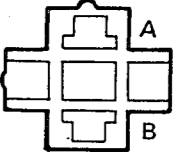
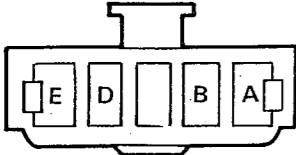
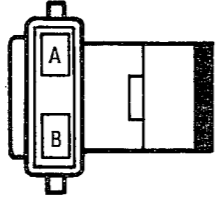
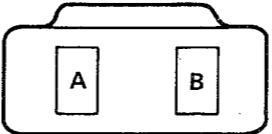
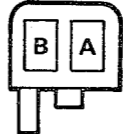

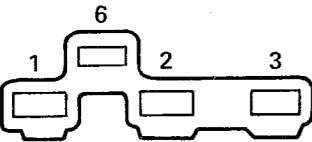
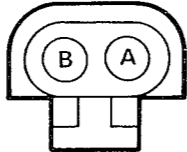
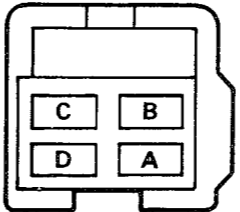
CONNECTOR VIEWS

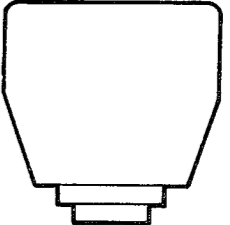
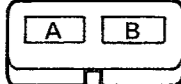
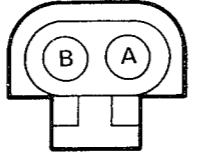
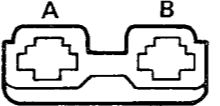
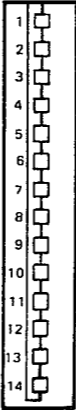
	<p>C214: Ignition module Next to RH shock tower</p> 	<p>C218: Map sensor Center rear of engine compartment</p> 	<p>C223: Throttle position sensor Next to throttle body</p> 	<p>C227: Power steering switch (2.5L) On LH side of throttle body</p> 	<p>C231: Sync sensor (4L) At distributor pigtail</p> 
	<p>C215: B+ latch relay Next to RH shock tower</p> 	<p>C219: Air temp sensor Next to throttle body</p> 	<p>C224: Engine speed sensor Lt. rear of cylinder head</p> 	<p>C228: Oxygen heater relay (4L) Next to RH shock tower</p> 	<p>C232: Knock sensor (4L) Behind LH engine mount</p> 
	<p>C216: Fuel pump relay Next to RH shock tower</p> 	<p>C220: Throttle position sensor Next to throttle body</p> 	<p>C225: Idle speed activator (2.5L) On RH side of throttle body</p> 	<p>C229: Oxygen sensor behind LH engine mount</p> 	<p>C233: Injectors (4L) LH side of rocker cover</p> 
	<p>C217: EGR solenoid Middle of RH fender well</p> 	<p>C221: Oxygen sensor Behind LH engine mount</p> 	<p>C226: Fuel injector (2.5L) Top of throttle body</p> 	<p>C230: Air stepper motor (4L) Next to throttle body</p> 	<p>C234: Transmission control unit (TCU) Behind RH I/P speaker mount</p> 
<p>C213: Ignition module Next to RH shock tower</p> 		<p>C222: Coolant temperature sensor Behind LH engine mount</p> 			

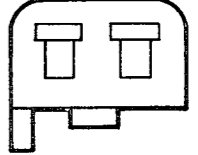
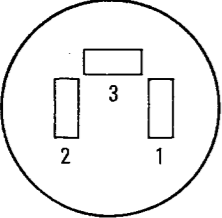
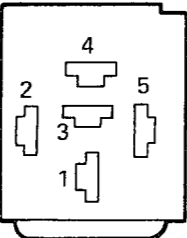
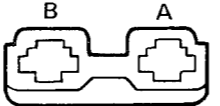
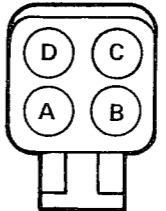
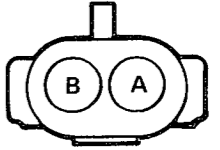



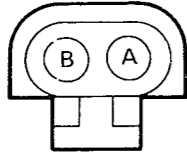
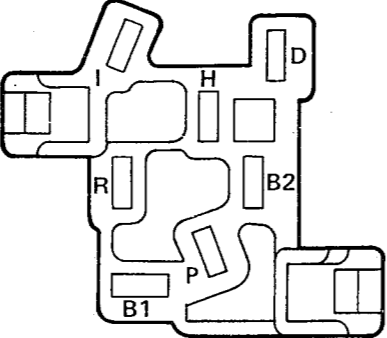
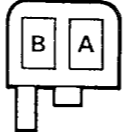
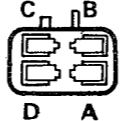
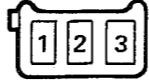
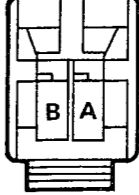
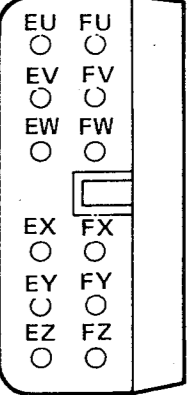
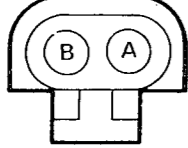
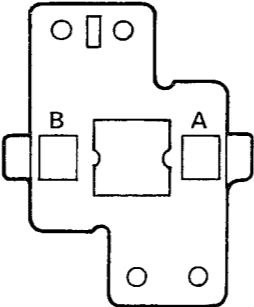

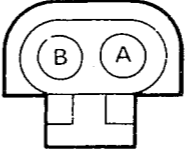
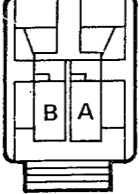
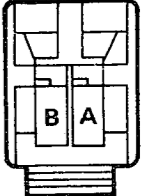
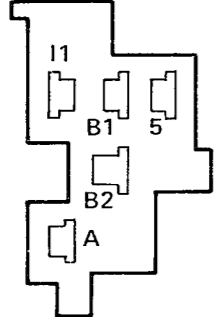
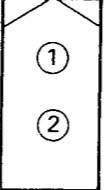
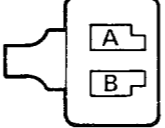
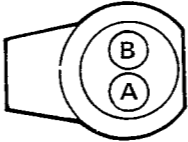
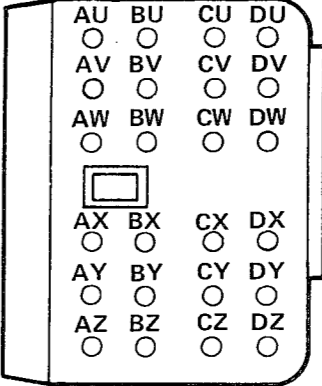
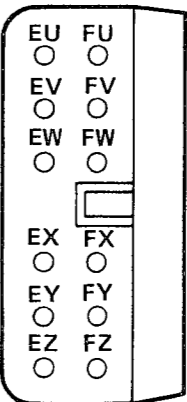
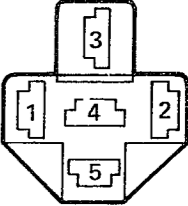
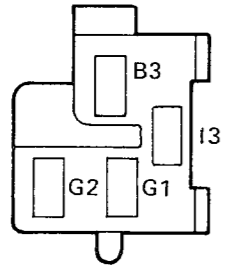
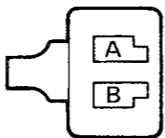
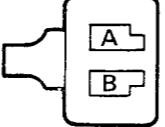
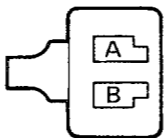
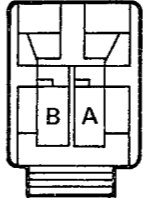
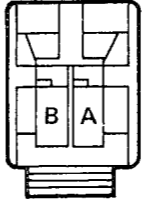
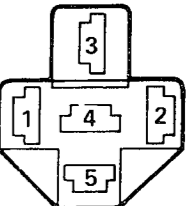



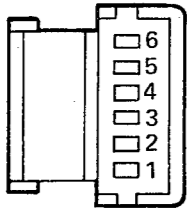
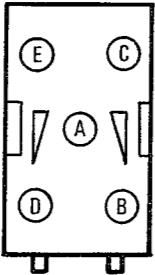
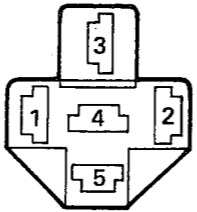
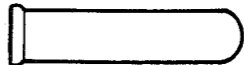
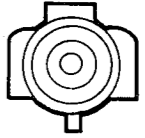
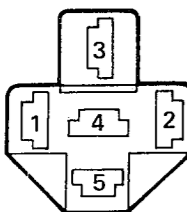
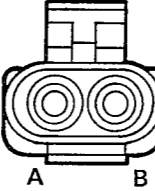
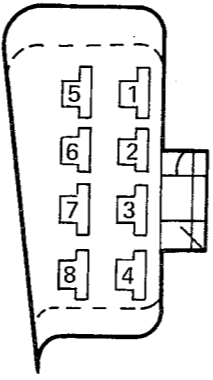
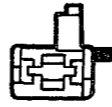

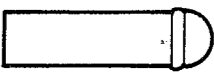
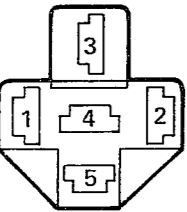
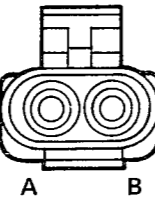
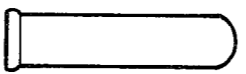
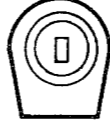
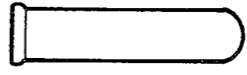
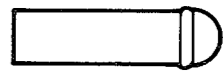
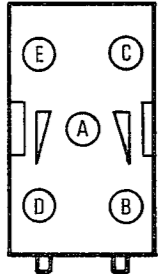
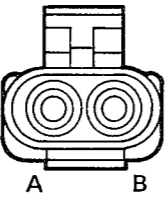
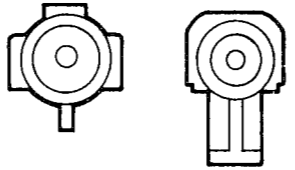
CONNECTOR VIEWS

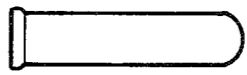
<p>C235: A/C blower switch In center of I/P</p> 	<p>C241: A/C clutch relay Next to RH shock tower</p> 	<p>C246: A/C diode module (4L) Below LH hood latch (taped to harness)</p> 	<p>C251: Cruise control clutch On clutch pedal support bracket</p> 	<p>C255: Cruise control servo On RH inner fender panel</p> 	<p>C260: Cruise/trans switch On brake pedal lever</p> 
<p>C236: A/C mode switch In center of I/P</p> 	<p>C242: Heater/A/C blower motor In evaporator/blower housing</p> 		<p>C252: Cruise control in-line fuse Under LH side of I/P near parking brake pedal</p> 	<p>C256: Cruise control speed sensor In-line speedo cable behind I/P</p> 	<p>C261: Power/comfort switch On LH side of I/P</p> 
<p>C237: Heater-A/C blower resistor RH front of evaporator/blower housing</p> 	<p>C243: Radiator temp. switch (4L) Below lt. hood release</p> 		<p>C253: Cruise control multi-function lever In upper part of steering column</p> 	<p>C257: Brake warning switch Below master cylinder</p> 	<p>C262: Fuse holder Behind blower resistor shield</p> 
<p>C238: A/C thermostat RH front of evaporator/blower housing</p> 	<p>C244: Fan motor (4L) Lt. of fan motor</p> 	<p>C249: Brake switch On brake pedal lever</p> 	<p>C254: Cruise control regulator module Under LH side of I/P above brake pedal</p> 	<p>C258: Upshift lamp switch On transmission housing</p> 	<p>C263: Resistor pak Behind blower resistor shield</p> 
<p>C239: A/C low pressure switch Lt. of radiator top</p> 	<p>C245: Fan control relay (4L) Front of washer bottle</p> 	<p>C250: Brake switch (cruise control) On brake pedal lever</p> 		<p>C259: Throttle position sensor Next to throttle body</p> 	<p>C264: 4 W/D & 4 W/D lock switch (4L Manual) LH side of transfer case</p> 

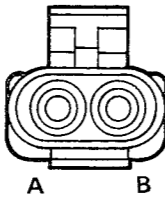
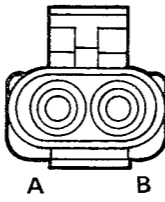
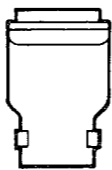
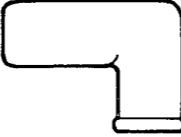

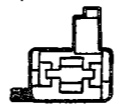

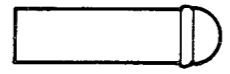







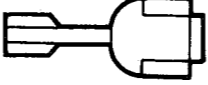
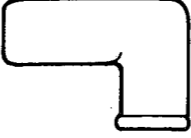
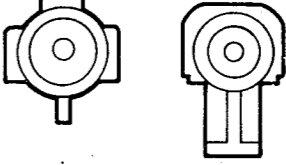





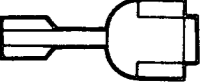

CONNECTOR VIEWS

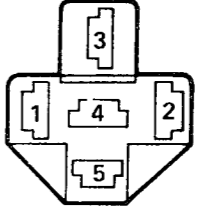
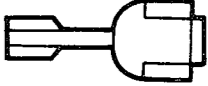
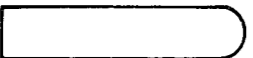
<p>C265: 4 W/D & 4 W/D lock (4L Auto) RH side of transmission</p> 	<p>C269: Headlamp switch On I/P lt. of steering column</p> 	<p>C272: Dome/reading lamp In center of header</p>  <p>C272A:</p> 	<p>C277: LH & RH dome/map lamp LH & RH rear top of cab</p> 	<p>C282: Left rear door lock motor Located in door</p> 	<p>C285: RH front door lock/power window switch In RH front door panel</p> 
<p>C266: 4 W/D & 4W/D lock (4L Auto) RH side of transfer case</p> 	<p>C271: Cargo lamp In cargo compartment header</p> 	<p>C273: Glove box lamp switch In glove box</p> 	<p>C278: Back up lamp switch 2.5L On transmission</p> 	<p>C283: Right rear door lock motor Located in door</p> 	<p>C286: Liftgate lock motor Located in liftgate</p> 
<p>C267: Ignition switch At base of steering column</p> 	<p>C271A: Cargo lamp switch Part of cargo lamp housing</p> 	<p>C274: LH courtesy lamp Under LH side of I/P above footwell</p> 	<p>C279: Back up lamp switch (4L) On transmission</p> 	<p>C284: Master door lock/power window switch In LH front door panel</p>  <p>C284A:</p> 	<p>C287: Lock relay Behind RH kick panel</p> 
<p>C268: Ignition switch At base of steering column</p> 	<p>C275: RH courtesy lamp Under RH side of I/P above footwell</p>  <p>C276: LH door jamb switch Above LH kick panel</p> 	<p>C275: RH courtesy lamp Under RH side of I/P above footwell</p> 	<p>C280: Left door lock motor Located in door</p> 	<p>C281: Right door lock motor Located in door</p> 	<p>C288: Unlock relay Behind RH kick panel</p> 

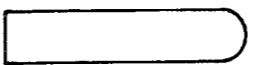
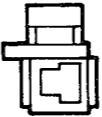
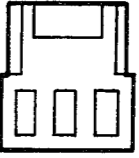
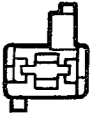



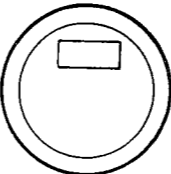
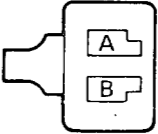

CONNECTOR VIEWS

<p>C289: Keyless entry module Front center of header panel</p> 	<p>C293: RH rear window switch Located in door</p> 	<p>C298: Stop lamp relay Above LH rear inner fender panel</p> 		<p>C309: A/C compressor clutch Lt. of battery</p> 	<p>C317: Cruise control ground Rt. rear of rocker cover</p> 
<p>C290: Right turn relay Above LH rear inner fender panel</p> 	<p>C294: Left power window motor Located in door</p> 	<p>C299: Chime module On side of fuse block</p> 	<p>C304: Ign—cruise control feed Plugs into fuse panel</p> 	<p>C310: Liftgate light switch In lower center of liftgate</p> 	<p>C318: Optional license lamp Center of liftgate</p> 
<p>C291: Left turn relay Above LH rear inner fender panel</p> 	<p>C295: Right power window motor Located in door</p> 	<p>C300: 4 W/D switch In front of blower motor</p> 	<p>C305: Fuel tank sender Located in fuel tank</p> 	<p>C311: Liftgate to liftgate (ground) In LH side of liftgate</p> 	<p>C319: License lamp Center of liftgate</p> 
<p>C292: LH rear window switch Located in door</p> 	<p>C296: Left rear power window motor Located in door</p> 	<p>C301: Upshift disconnect (2.5L) Next to RH shock tower</p> 	<p>C306: Fuel tank sender ground Located in fuel tank</p> 	<p>C312: LH rear door jamb switch At LH rear door pillar base</p> 	<p>C320: Optional license lamp (ground) Center of liftgate</p> 
<p>C297: Right rear power window motor Located in door</p> 	<p>C297: Right rear power window motor Located in door</p> 	<p>C302: Parking brake switch In console</p> 	<p>C307: Temperature sender Top LH rear of engine</p> 	<p>C313: RH front door jamb switch Near RH door jamb switch</p> 	<p>C321: License lamp (ground) Center of liftgate</p> 
			<p>C308: Pwr accy - power window feed Plugs into fuse panel</p> 	<p>C314: RH rear door jamb switch At RH rear door pillar base</p> 	<p>C322: Defogger (ground) In LH side of liftgate</p> 
				<p>C315: Vanity lighted mirror In RH visor</p> 	<p>C323: Liftgate to liftgate In LH side of liftgate</p> 
				<p>C316: Cargo box lamp Center rear of header</p> 	

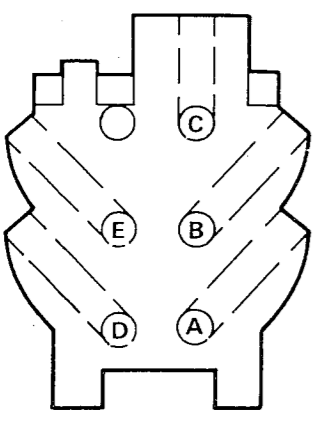
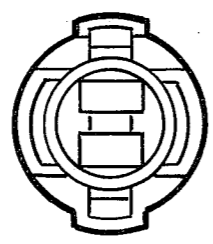
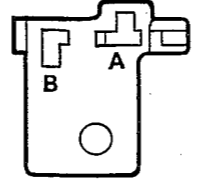
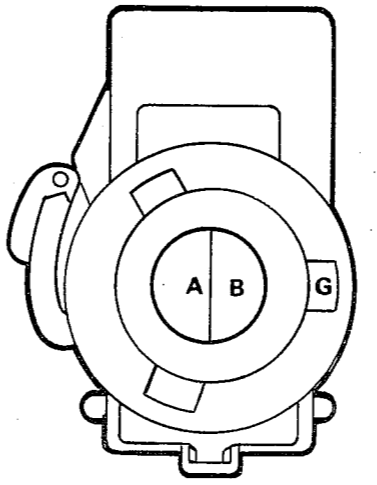
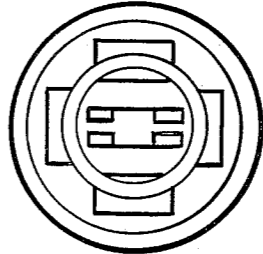
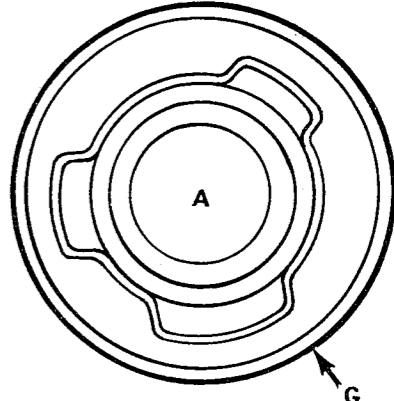
CONNECTOR VIEWS

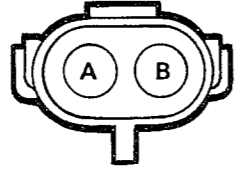
<p>C324: Liftgate to liftgate In LH side of liftgate</p> 	<p>C329: Horn Below RH parking lamp</p> 	<p>C334: Cigar lighter (ground) Under I/P next to ash tray</p> 	<p>C339: Cigar lighter Behind cigar lighter</p> 	<p>C352: Engine to EEC Next to RH shock tower</p> 	<p>C357: Cigar lighter lamp Behind cigar lighter</p> 
<p>C325: Trailer tow fuse Behind LH rear inner fender panel</p> 	<p>C330: Underhood lamp Near underhood lamp</p> 	<p>C335: Engine to alternator Behind battery</p> 	<p>C340: Liftgate switch In lower center of liftgate</p> 	<p>C353: Defogger grid RH side of liftgate</p> 	<p>C358: Radio (ground) On back of radio</p> 
<p>C326: Trailer tow fuse Behind LH rear inner fender panel</p> 	<p>C331: Starter In front of LH shock tower</p> 	<p>C336: A/C blower resistor RH front of evaporator/blower housing</p> 	<p>C341: Vanity lighted mirror in RH visor</p> 	<p>C354: Radio/Clock Illumination Relay Under LH side of I/P, behind kick panel</p> 	<p>C359: Headlamp (ground) On back of headlamp switch</p> 
<p>C327: Defogger At defogger grid on liftgate</p> 	<p>C332: Starter In front of LH shock tower</p> 	<p>C337: RH rear jamb switch Under RH side of I/P at kick panel</p> 	<p>C342: Liftgate to liftgate In LH side of liftgate</p> 	<p>C355: Emission maintenance timer Behind center of I/P</p> 	<p>C361: Batt Plugs into fuse panel</p> 
<p>C328: Trailer tow fuse Behind LH rear inner fender panel</p> 	<p>C333: Starter In front of LH shock tower</p> 	<p>C338: Pwr accy circuit breaker Plugs into fuse panel</p> 	<p>C343: Oil pressure sender or switch Front lower RH side of engine block</p> 	<p>C356: Ash tray lamp Behind ash tray</p> 	<p>C362/C363: Ballast resistor LH side of radiator</p> 

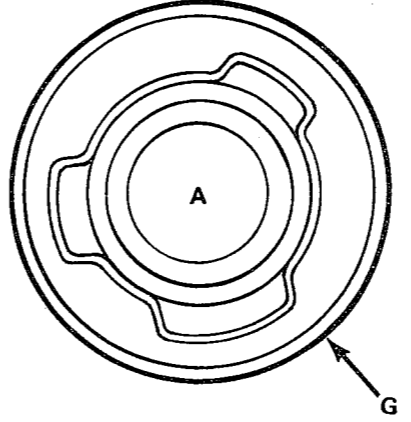
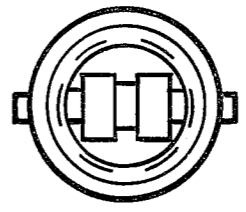
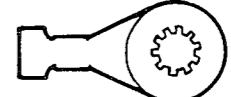
CONNECTOR VIEWS/GROUND CONNECTORS

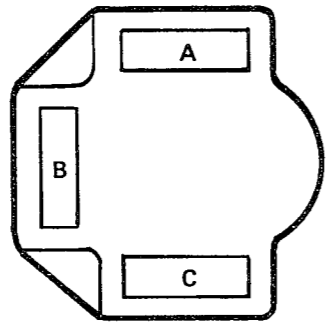
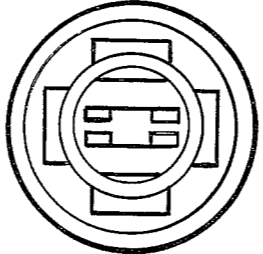
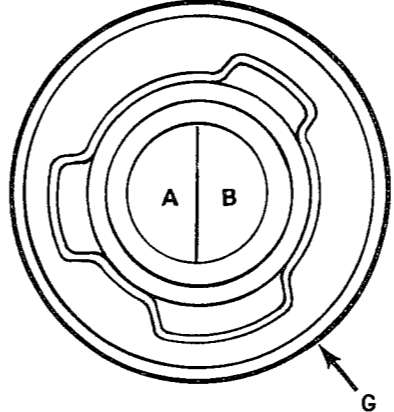
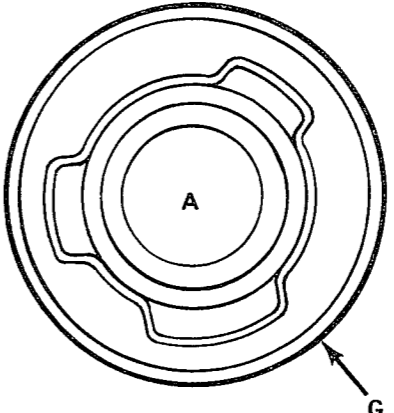
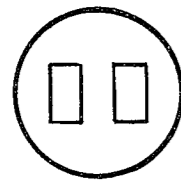
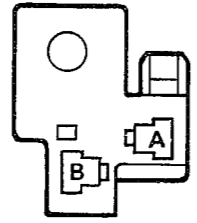
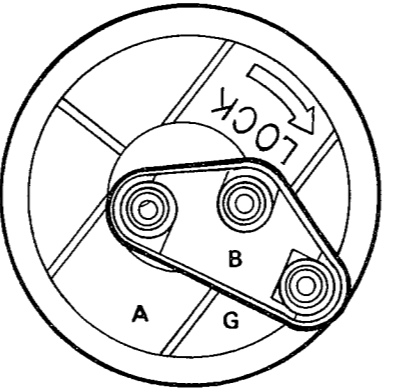
<p>C364/365: Front door/lock switches Located in door</p> 	<p>C369: Transfer Case Lamp In center console</p> 	<p>C376/C377: Hi Beam Headlamps Behind headlamp</p> 	<p>C383/C384: Front Parking/Turn Lamps - w/Quad Headlamps Behind lamp</p> 	<p>C394/C395: License Lamps Behind lamp</p> 	<p>C400/401: Rear Turn Lamps Behind lamp</p> 
<p>C366: Cargo Lamp Switch LH side of steering column</p> 	<p>C370/371: Fog Lamp Behind grille</p> 	<p>C378: Starter Relay-4L LH side of front shock tower</p> 	<p>C385/C386: Tail Lamps Behind lamp</p> 	<p>C396/C397: License Lamps Behind lamp</p> 	<p>G100: Ground Near alternator</p> <p>G102: Ground On LH lower dash brace of I/P</p> <p>G103: Ground On LH inner fender panel (2.5/4L only)</p> <p>G104: Ground On oil dipstick brace mounting bolt (2.5/4L only)</p> <p>G105: Ground On oil dipstick brace mounting bolt (2.5/4L only)</p> <p>G106: Ground On LH inner fender panel (4L only)</p> <p>G107: Ground Behind LH rear inner fender panel</p> 
<p>C367: Heater A/C Control Head Lamp Behind control head</p> 	<p>C372/C373: Dual Beam Headlamps Behind headlamp</p> 	<p>C379/C380/C381/C382: Side Marker Lamps Behind lamp</p> 	<p>C387-C393: Tail Lamps Behind lamp</p> 	<p>C398/C399: Backup Lamps Behind lamp</p> 	
<p>C368: PRNDL Lamp In center console</p> 	<p>C374/C375: Lo Beam Headlamps Behind headlamp</p> 	<p>C383/C384: Front Parking/Turn Lamps - w/Dual Headlamps Behind lamp</p> 			

2.5L INJECTOR HARNESS

HARNESS CODES			
CODE	HARNESS	CODE	HARNESS
A	Alternator	IP	Instrument Panel
AC	Air Conditioner	L	Liftgate
B	Body	LF	Left Front Door
BAT	Battery	LL	License Lamp
BL	Body to Liftgate	LR	Left Rear Door
CC	Cruise Control	P	Power Seat
CL	Cargo Lamp	RC	Rear Cross Body
DL	Dome Lamp	RF	Right Front Door
E	Engine	RR	Right Rear Door
EC	Engine Control	T	Transmission
FC	Front Crossbody	TL	Tail Lamps
FL	Front Lamps	TR	Trailer Relay
H	Heater	TT	Trailer Tow
IN	Injector	UB	Underbody

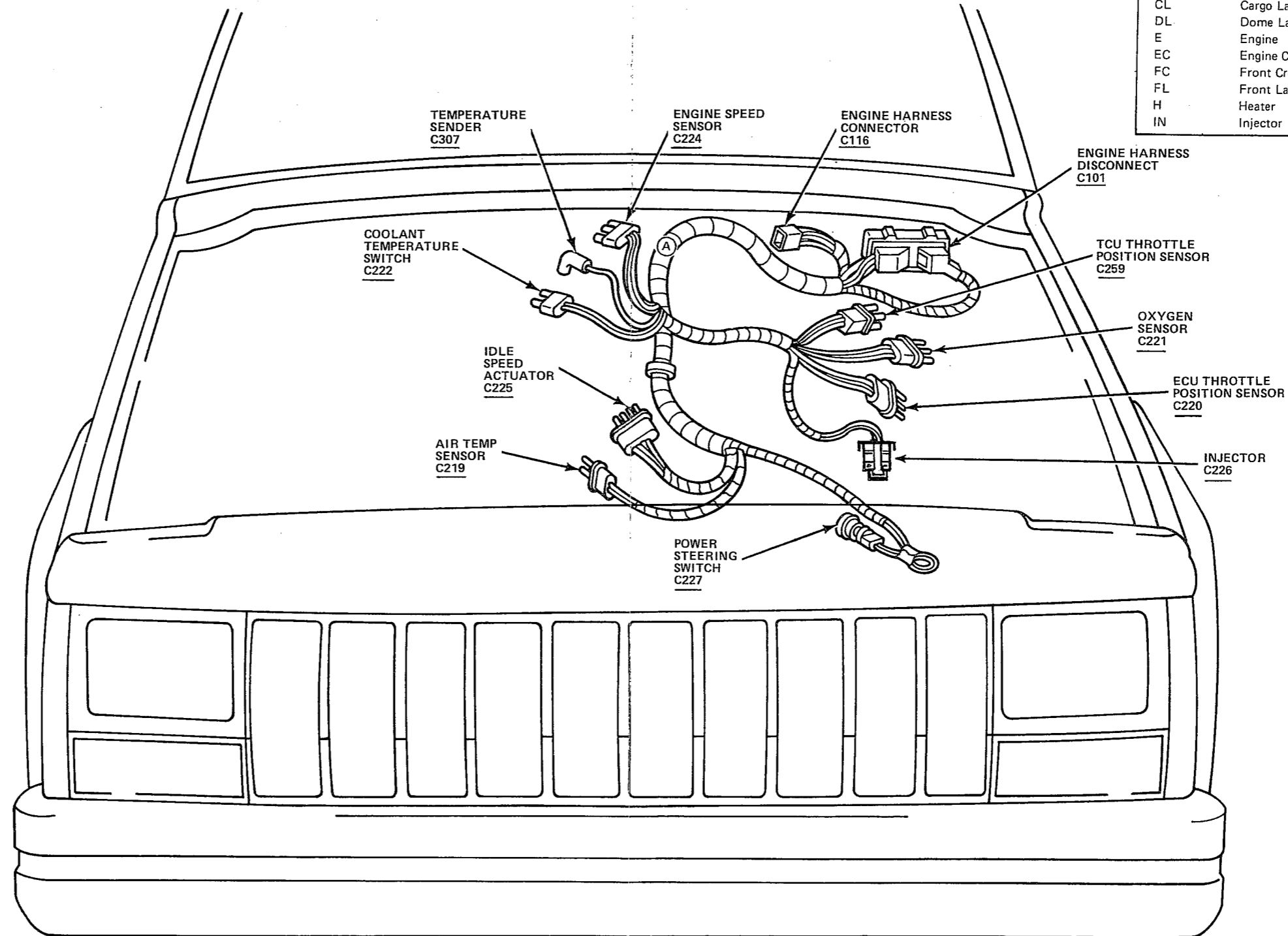

2.5L ENGINE CONTROL HARNESS

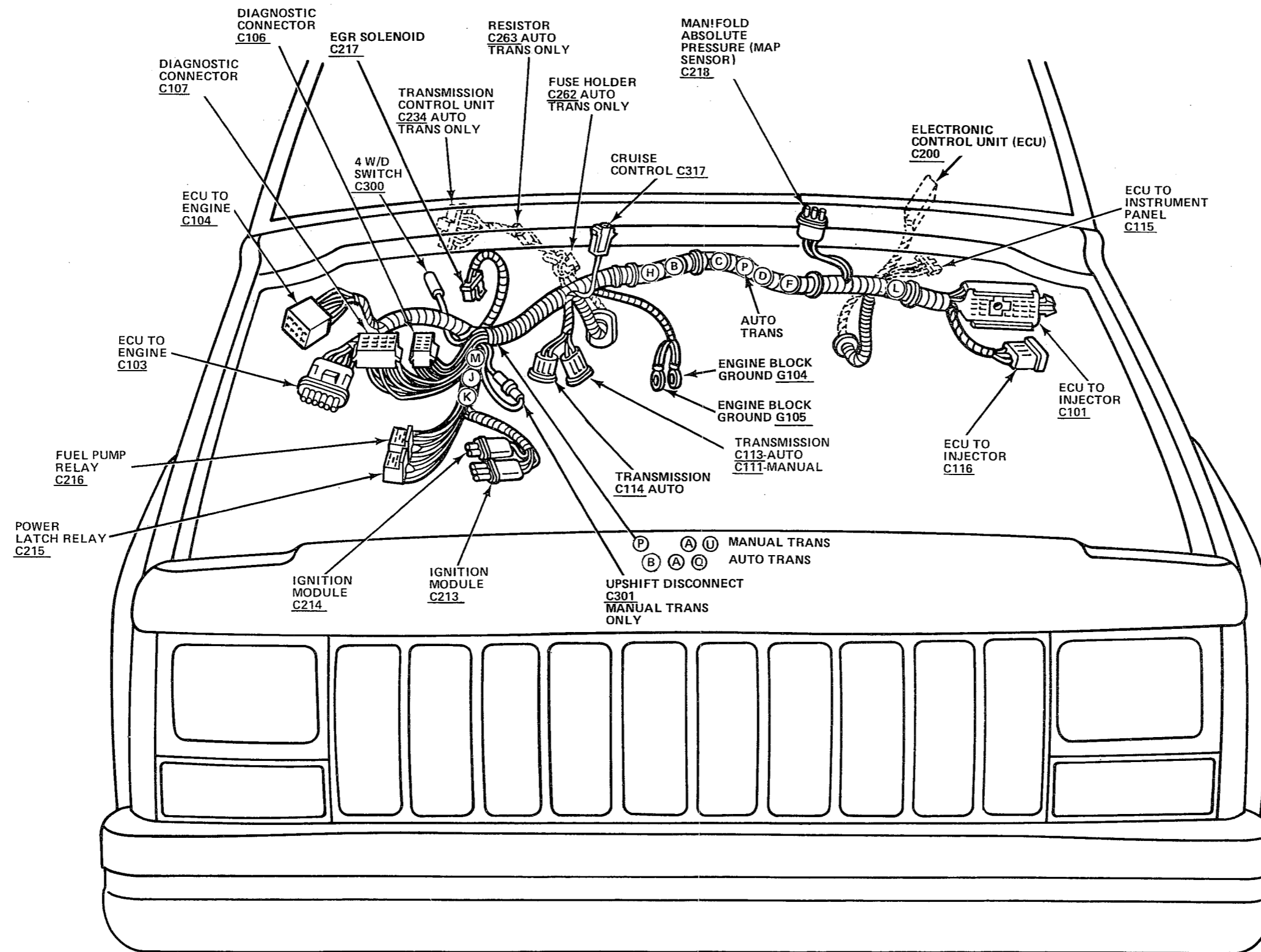

2.5L ENGINE HARNESS

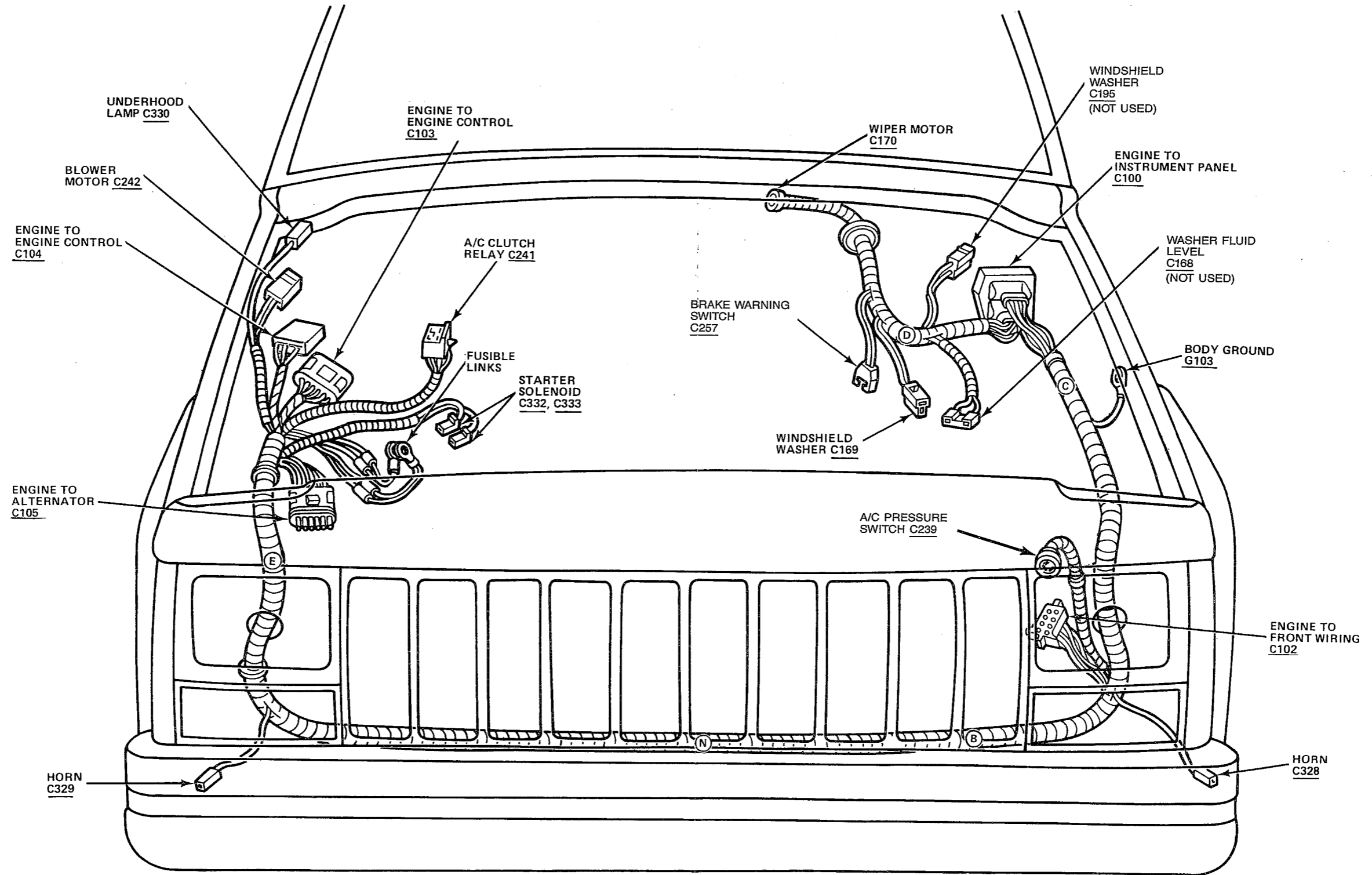

4L INJECTOR HARNESS

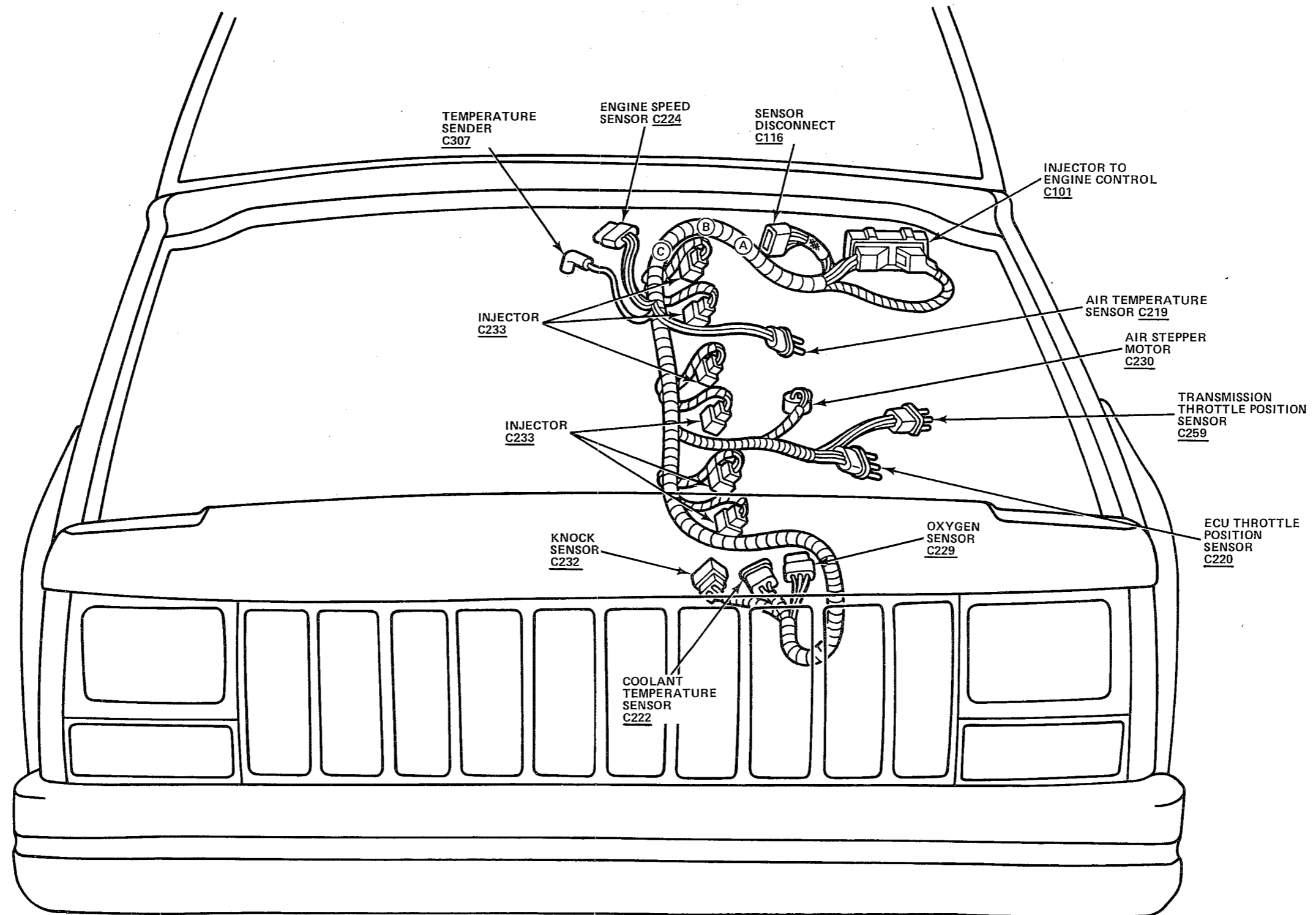

4L ENGINE CONTROL HARNESS

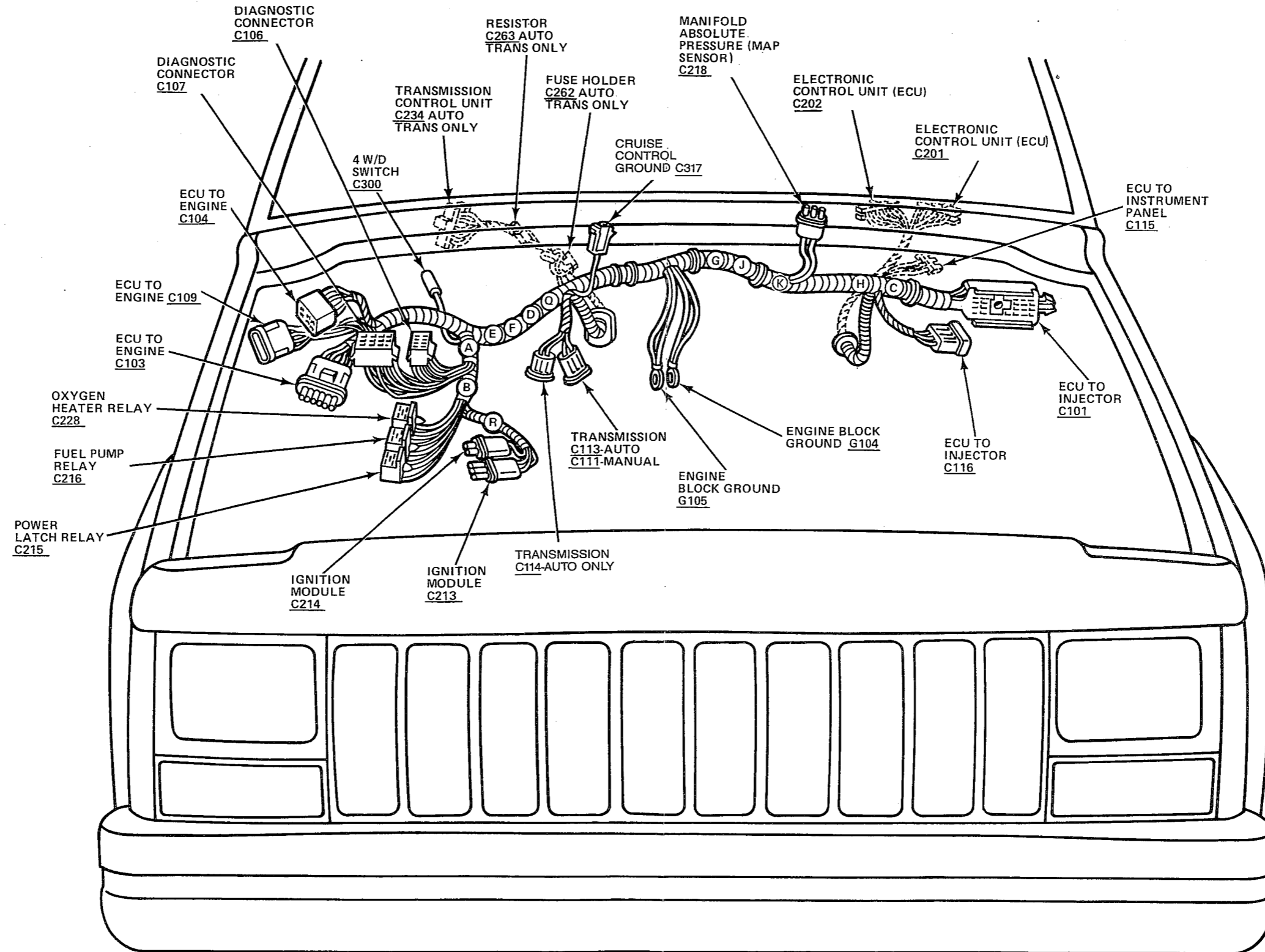

4L ENGINE HARNESS

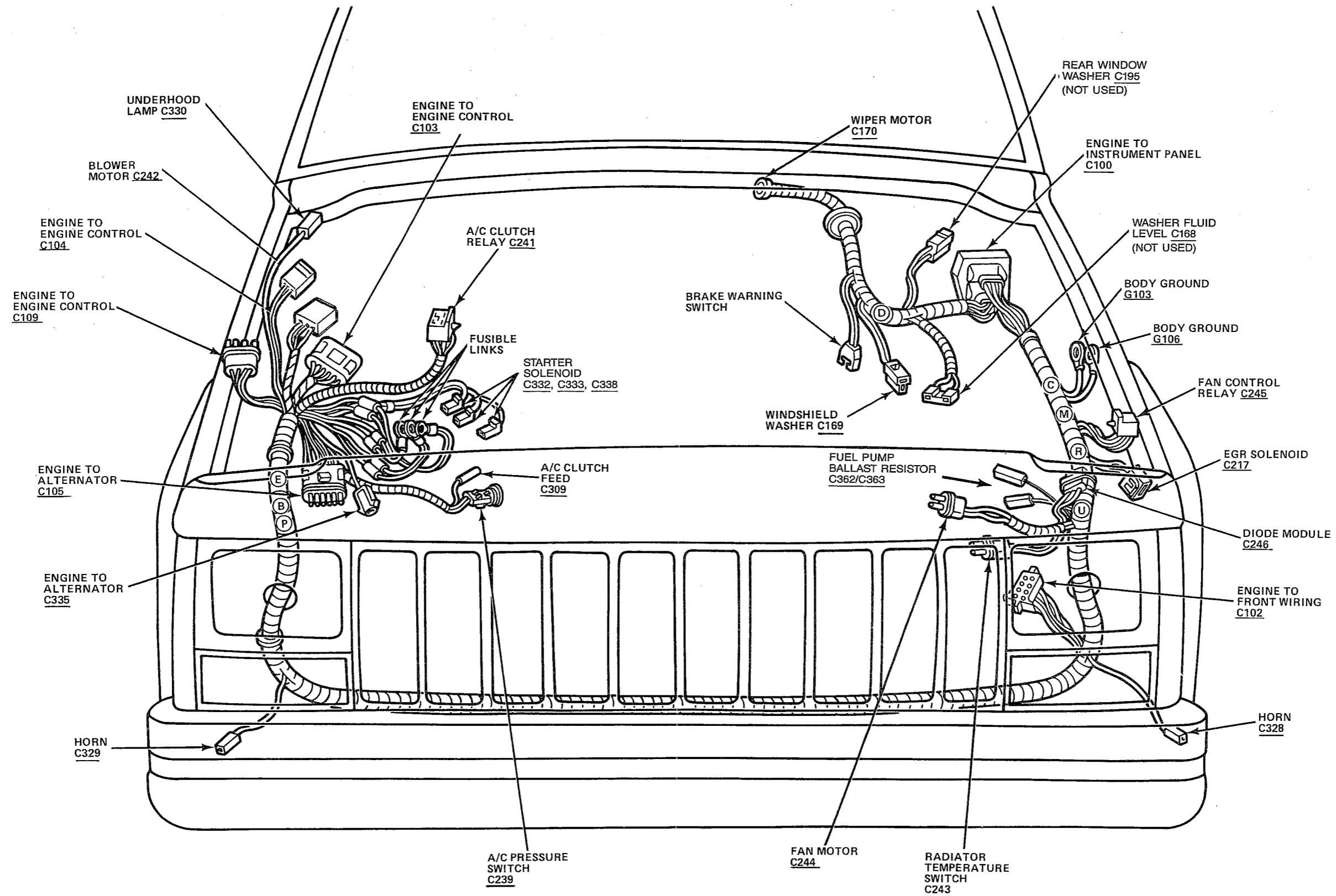

INSTRUMENT PANEL HARNESS HEATER/AIR CONDITIONING HARNESS 2.5L/4L

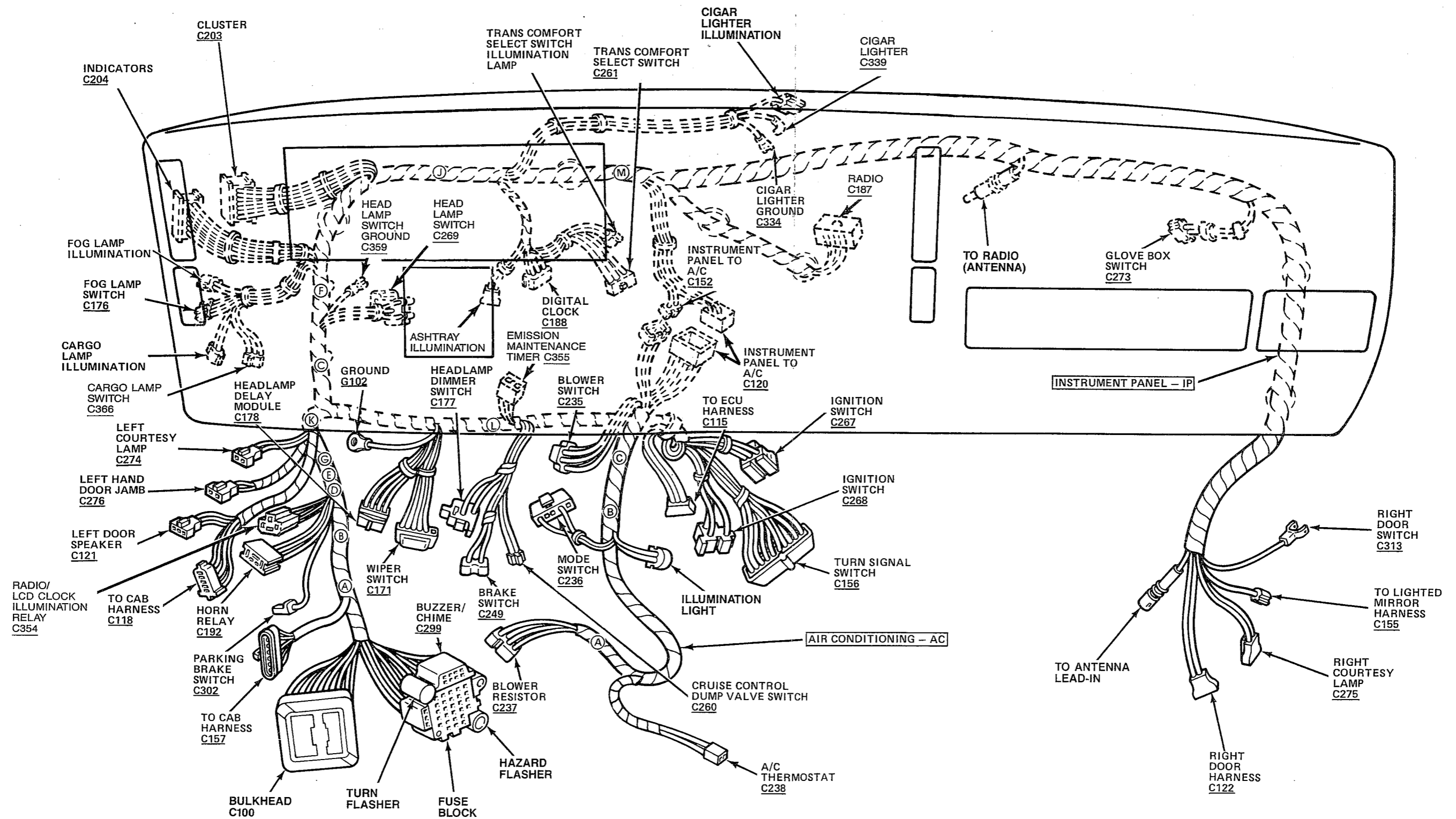

CAB HARNESSSES

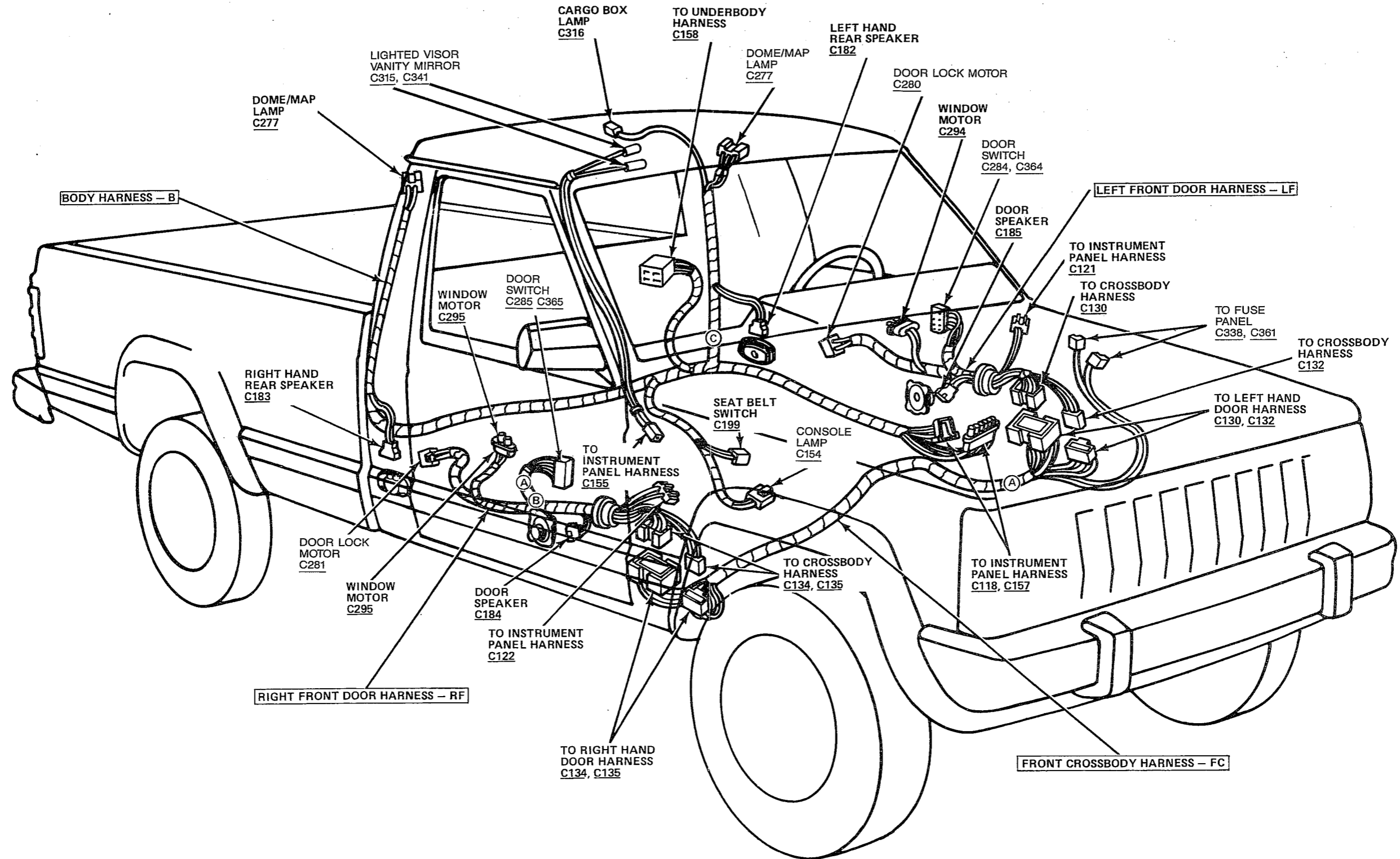

FRONT LIGHTING, UNDERBODY AND CRUISE CONTROL HARNESSSES

NOTE: Some two-pin connectors are not shown on this view. These connectors are generally located at the connecting component. Connector identification, location and configuration for these connectors can be found in the "Inline Connector Views" section of this manual.

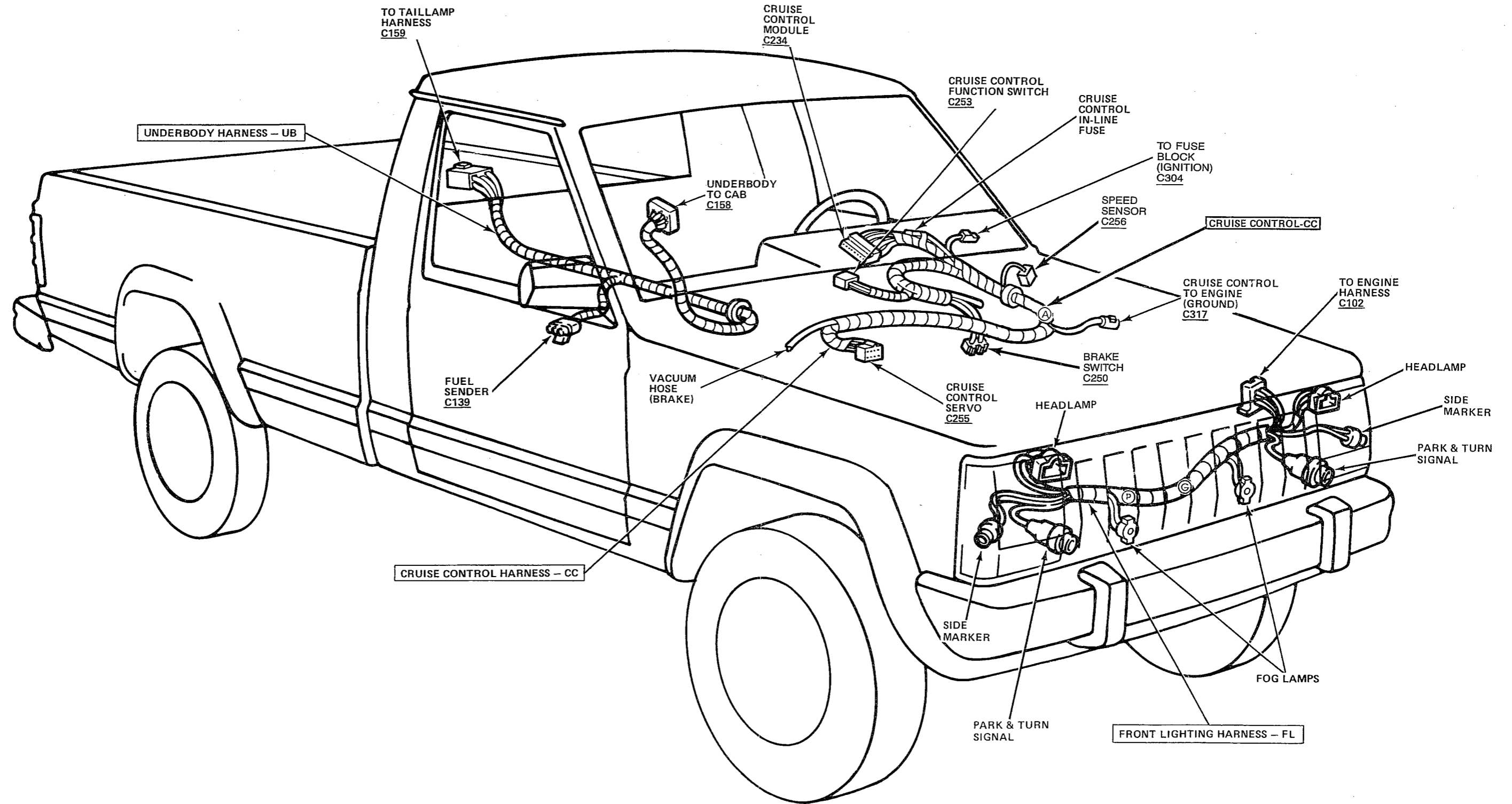

TAIL LAMP HARNESS LICENSE LAMP HARNESS

NOTE: Some two-pin connectors are not shown on this view. These connectors are generally located at the connecting component. Connector identification, location and configuration for these connectors can be found in the "Inline Connector Views" section of this manual.

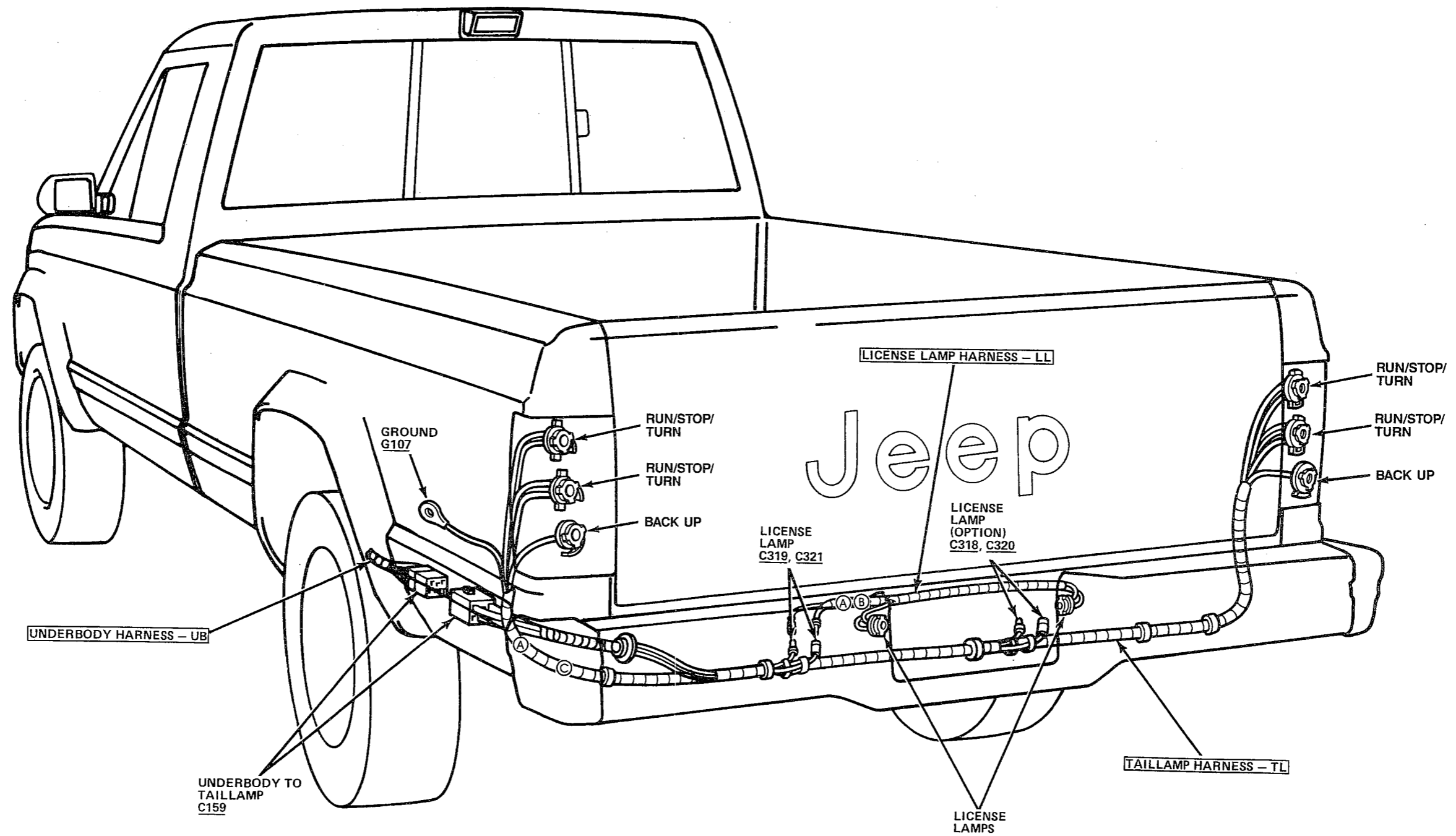

INSTRUMENT CLUSTERS

TER-MINAL	LAMP	
1	A	BLANK
2	B	CHECK ENGINE
3	B	CHECK ENGINE
4	—	IGN. FEED
5	—	ALT. FEED
6	C	BLANK
7	D	NOT USED
8	E	BRAKE
9	F	SEAT BELT
10	F	SEAT BELT
11	G	FULL TIME
12	H	SHIFT LAMP
13	K	PART TIME
14	K	PART TIME
15	J	LOW WASHER
16	—	GROUND

CONNECTOR C204
INDICATORS

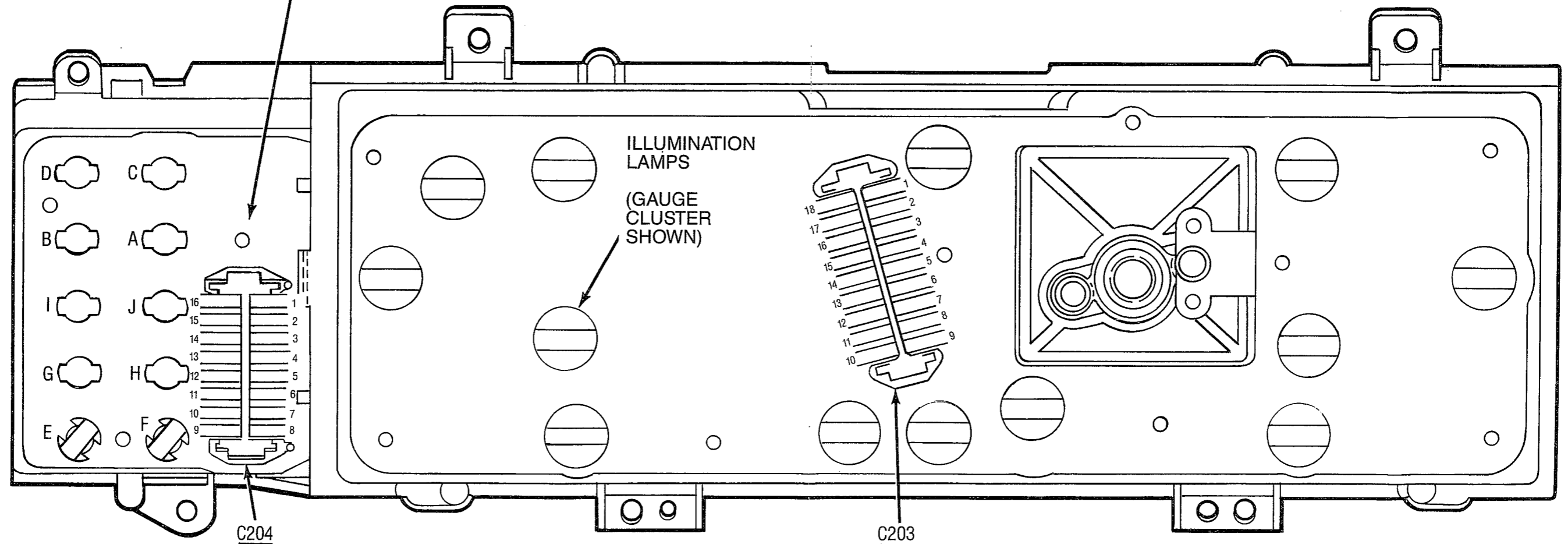
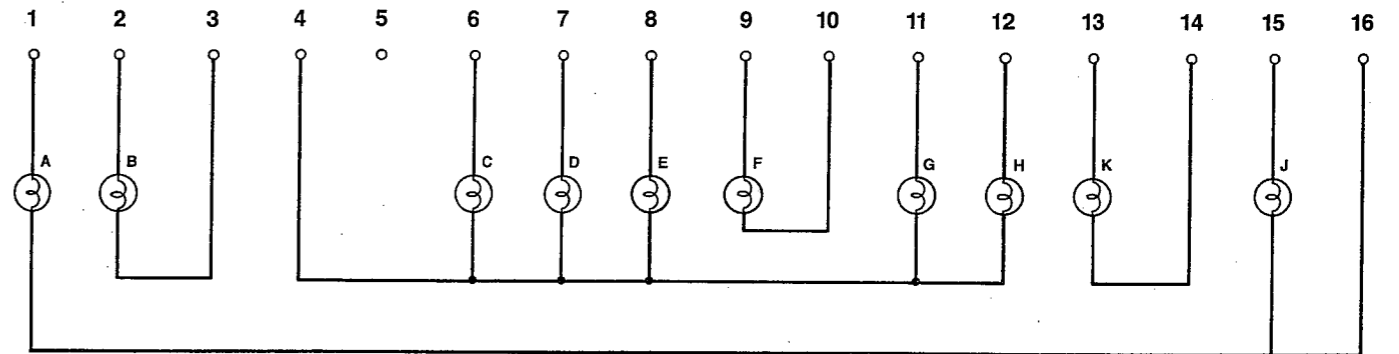

INSTRUMENT CLUSTERS

STANDARD

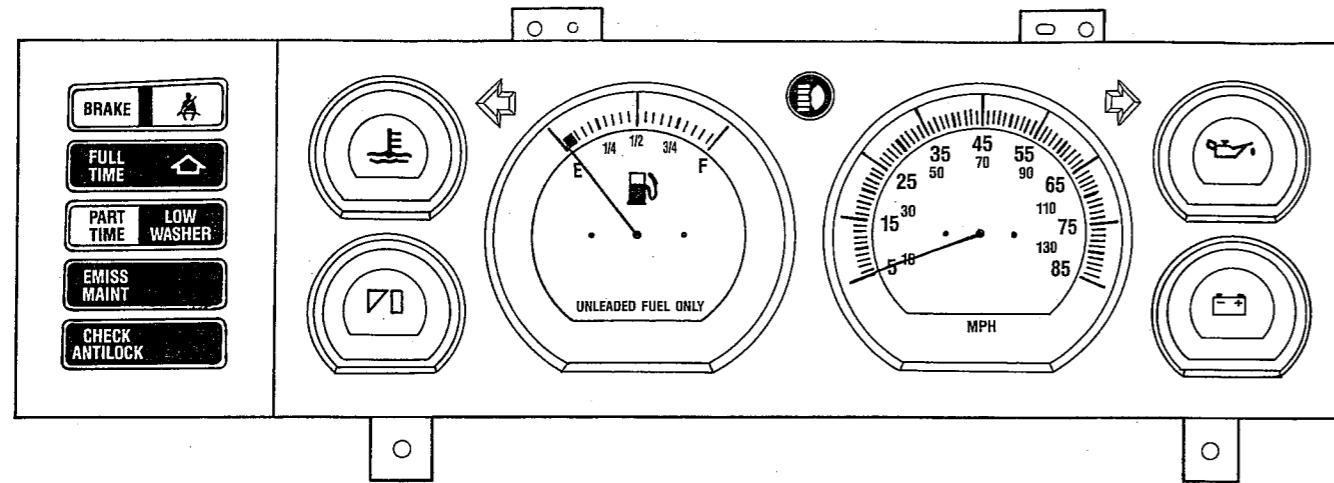

GAUGES

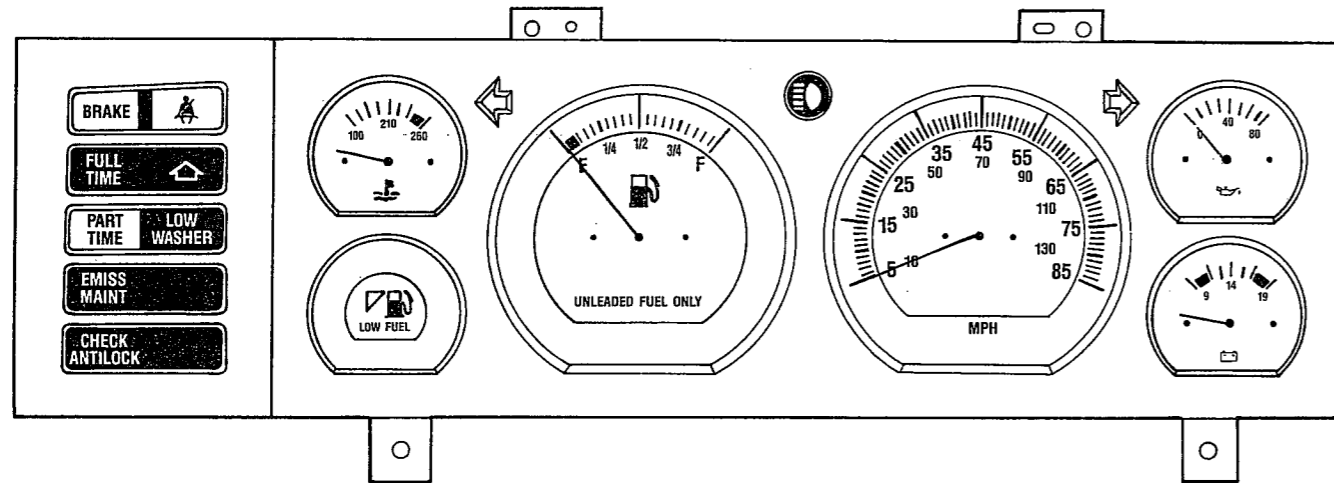

HIGH LINE

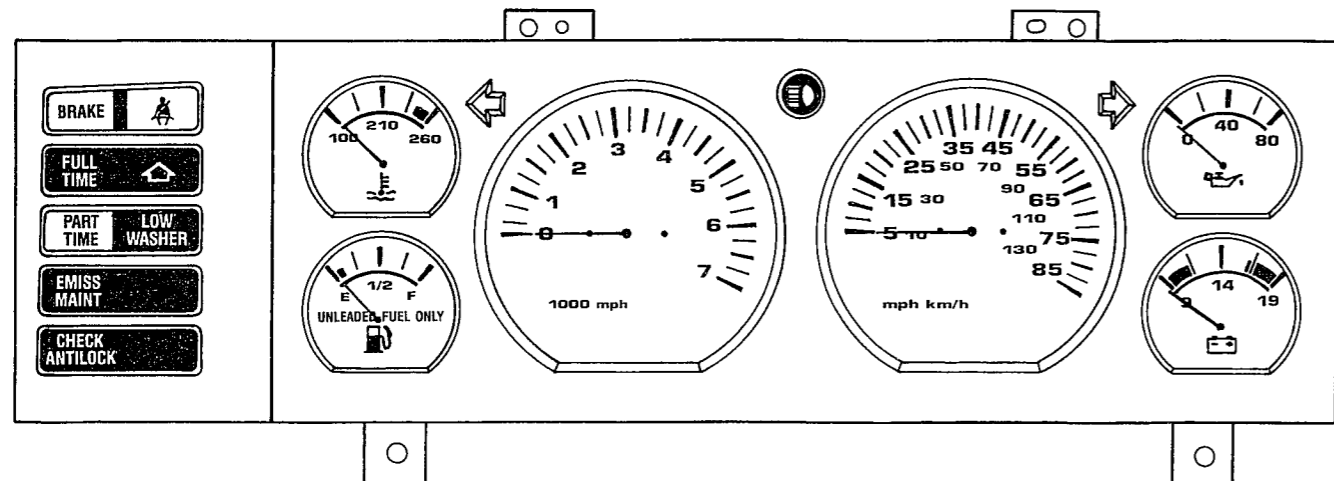

CONNECTOR C203

STANDARD

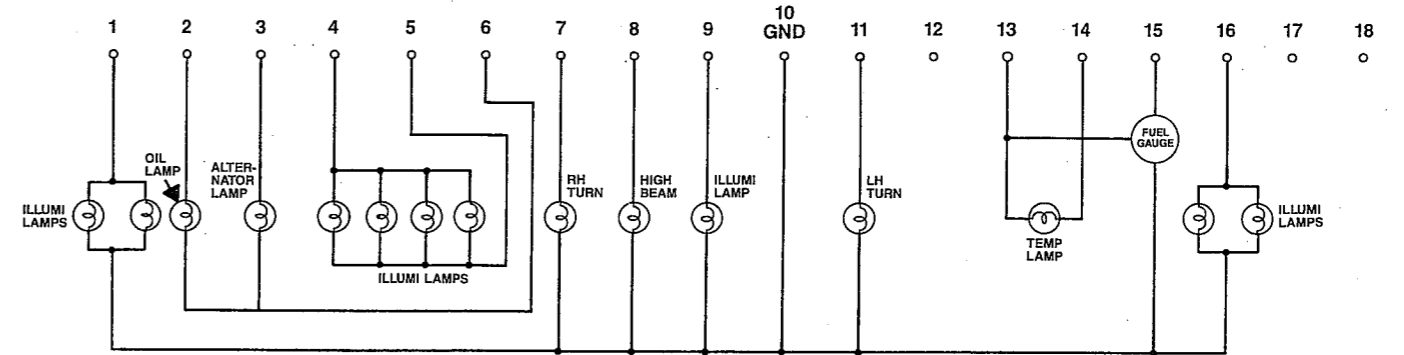

GAUGES

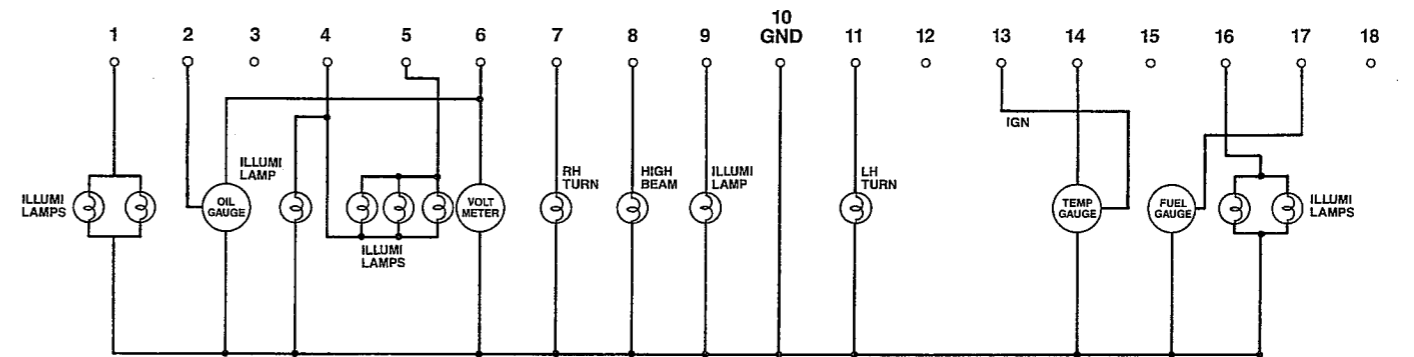

HIGH LINE

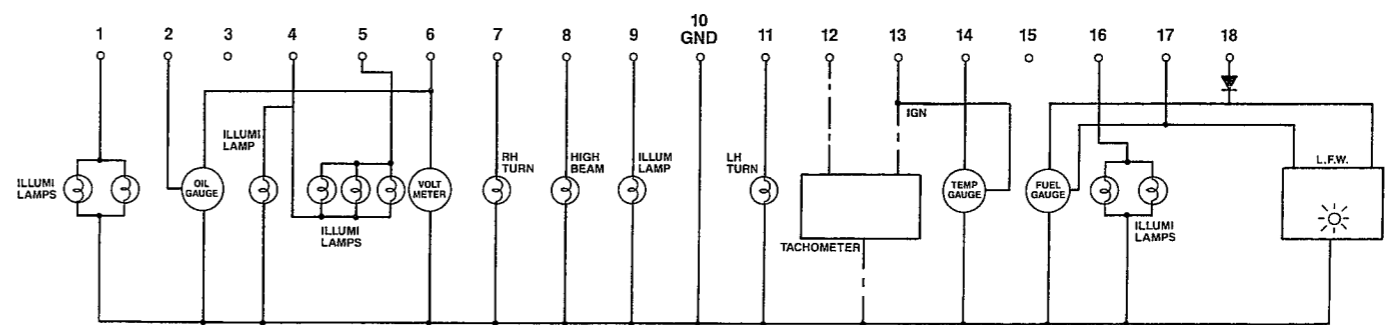

SWITCH TESTING

HEADLAMP SWITCH

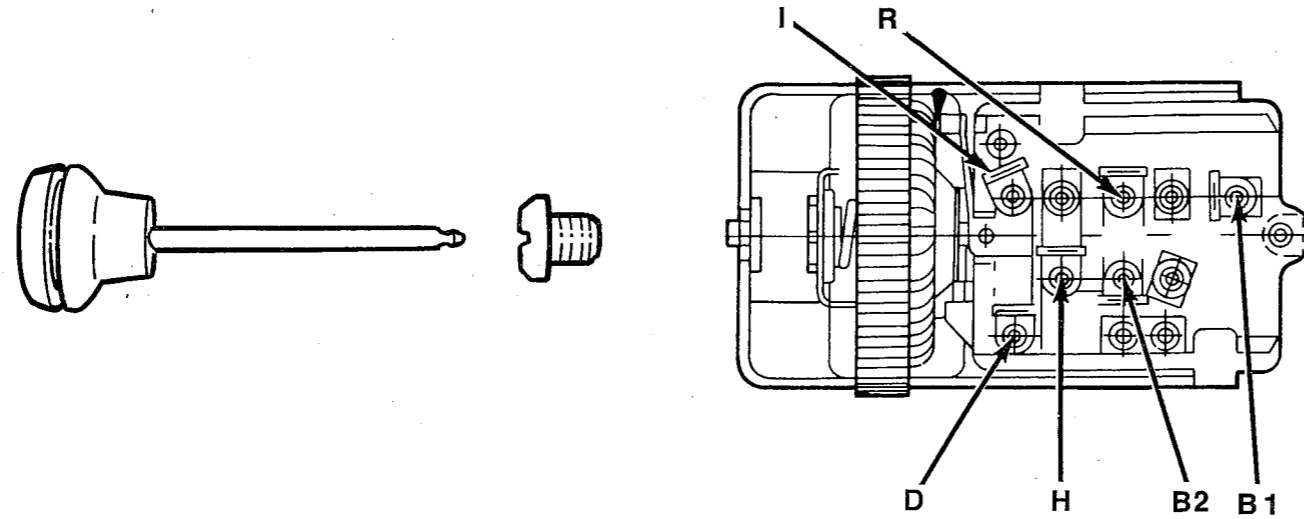

SWITCH DIAGRAM

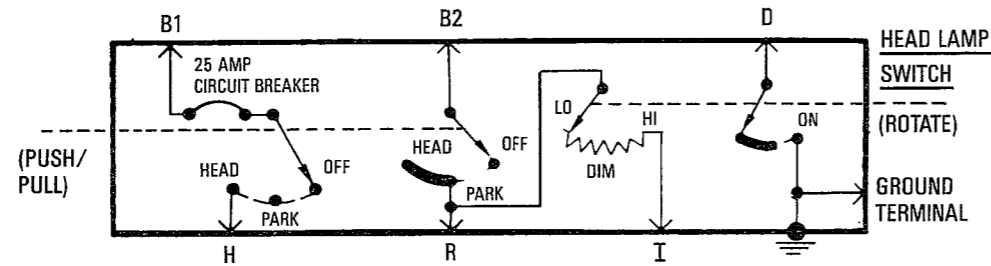

IGNITION SWITCH

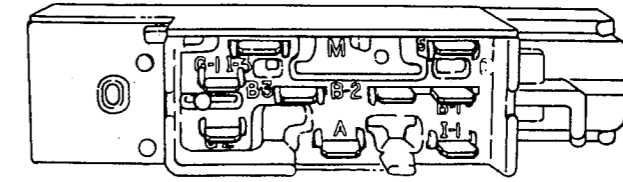

SWITCH DIAGRAM

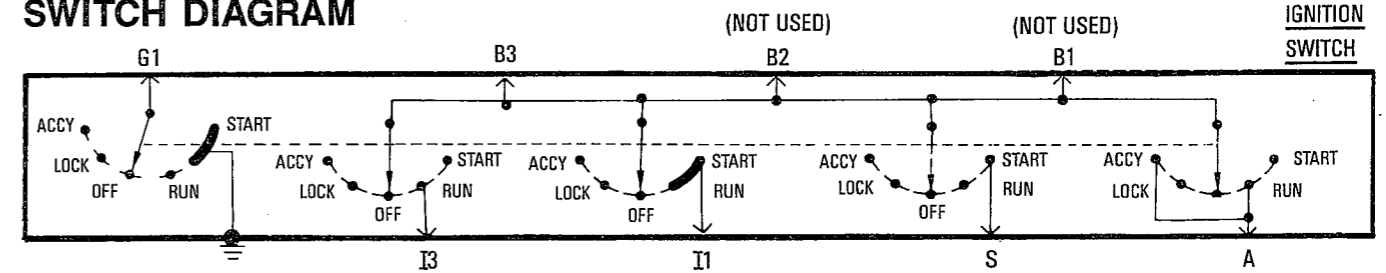

SWITCH TEST

SWITCH POSITION	TERMINALS	ZERO OHMS
Off	Any Terminals	No
Park	B2 and R	Yes
Head	B1 and H	Yes
	B 2 and R	Yes
	All Others	No
Knob Turned C.W. and Pulled Out to Park Position	B2 and I	Yes
	B2 and R	Yes
	All Others	No
Knob Turned Fully C.W.	D and Ground Terminal	Yes
	All Others	No

SWITCH TEST

SWITCH POSITION	TERMINALS	ZERO OHMS
Off or Lock	All Terminals	No
ACCY	B3 and A	Yes
	All Others	No
Run	B3 and I3	Yes
	B3 and I1	Yes
	B3 and A	Yes
	All Others	No
Start	G1 and Mounting Bracket	Yes
	B3 and I1	Yes
	B3 and S	Yes
	All Others	No

SWITCH TESTING

STEERING COLUMN WIRING HARNESS

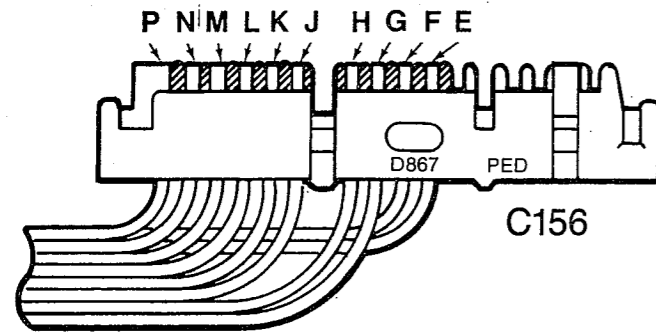
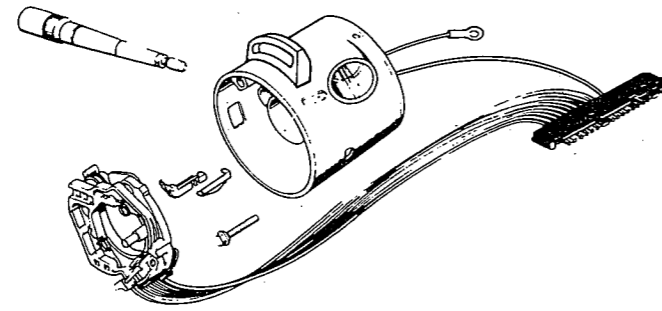

- P — STOP LIGHT SWITCH
 - N — RIGHT REAR TURN SW
 - M — LEFT REAR TURN SW
 - L — FLASHER
 - K — HAZARD WARNING
 - J — RIGHT FRONT TURN SW
 - H — LEFT FRONT TURN SW
 - G — HORN
 - F — KEY ALARM
 - E — KEY ALARM
- WHITE
 - DARK GREEN
 - YELLOW
 - PURPLE
 - BROWN
 - DARK BLUE
 - LIGHT BLUE
 - BLACK
 - GREEN
 - BROWN

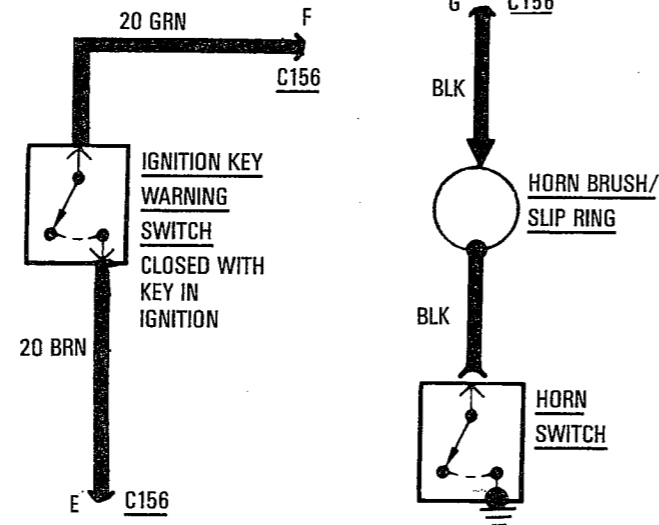

SWITCH TEST

SWITCH POSITION	TERMINALS	ZERO OHMS
Key in Ignition	E and F	Yes
Horn Button Depressed	G and clean chassis ground	Yes
Left Turn On	H and L	Yes
Right Turn On	J and L	Yes
Hazard Switch On	K and: H, J, M, N, P	Yes
Left Turn On	M and L	Yes
Right Turn On	N and L	Yes
Turn Signal Off	P and M	Yes
	P and N	Yes

SWITCH DIAGRAM

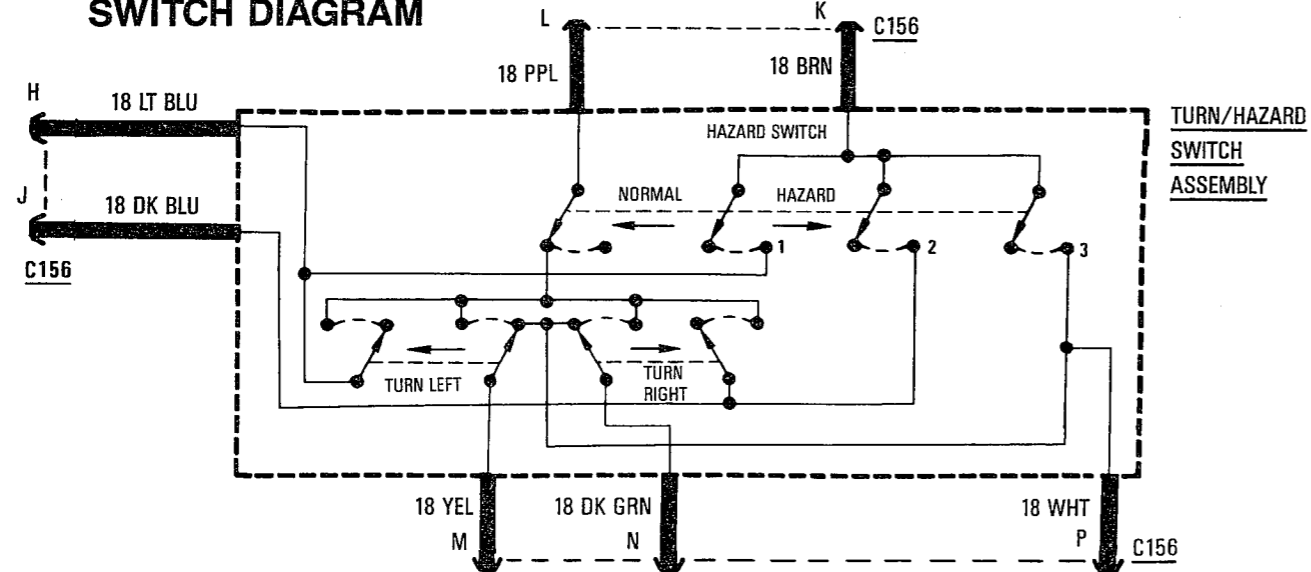

SWITCH TESTING

STANDARD WIPER/WASHER

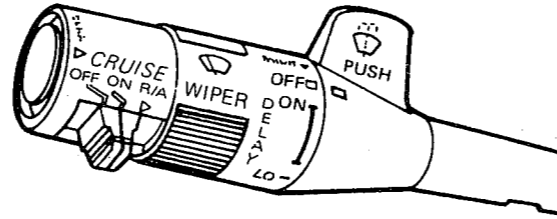
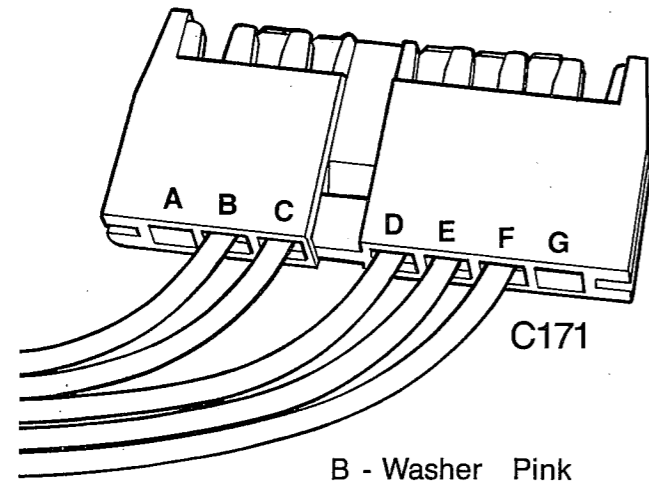

- B - Washer Pink
- C - Hi Violet
- D - Ignition White
- E - Lo/Park Gray
- F - Off/Park Yellow

SWITCH DIAGRAM

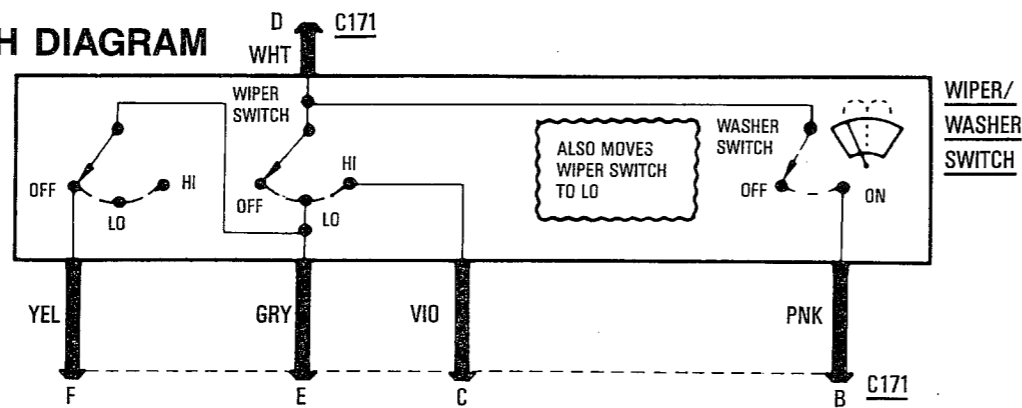

INTERMITTENT WIPER/WASHER

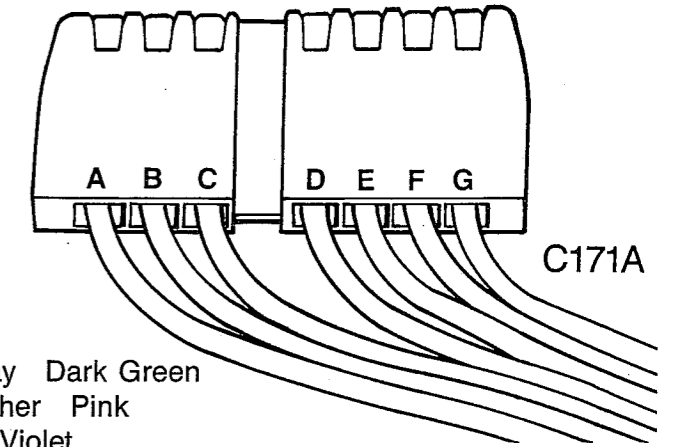
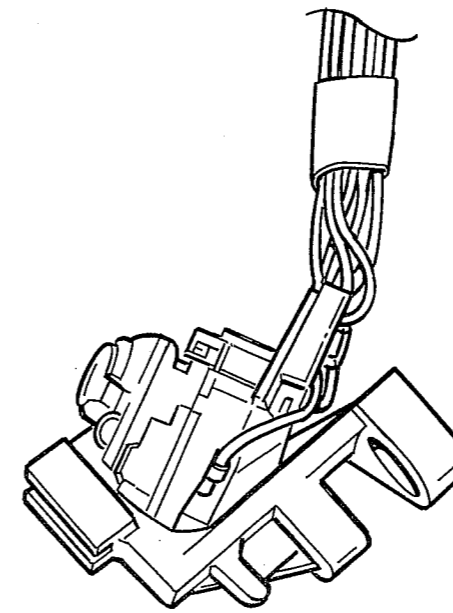

- A - Delay Dark Green
- B - Washer Pink
- C - Hi Violet
- D - Ignition White
- E - Lo/Mist/Park Gray
- F - Off/Park Yellow
- G - Delay Brown

SWITCH DIAGRAM

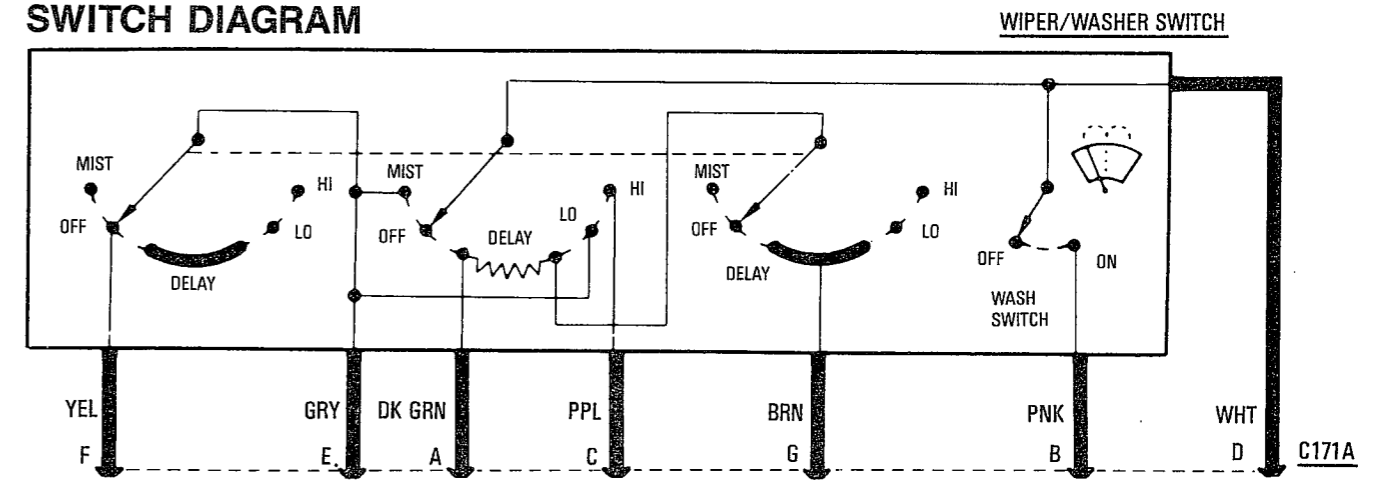

SWITCH TEST

SWITCH POSITION	TERMINALS	ZERO OHMS
Off	E and F	Yes
	All Others	No
Lo	D and E	Yes
	All Others	No
Hi	C and D	Yes
	All Others	No
Wash	B and D	Yes
	D and E	Yes
	All Others	No

SWITCH TEST

SWITCH POSITION	TERMINALS	ZERO OHMS
Off	E and F	Yes
	All Others	No
Lo	D and E	Yes
	All Others	No
Hi	C and D	Yes
	All Others	No
Wash/Mist	B and D	Yes
	D and E	Yes
	All Others	No
Delay	A and G	152-480K ohms

SWITCH TESTING

CRUISE SWITCH

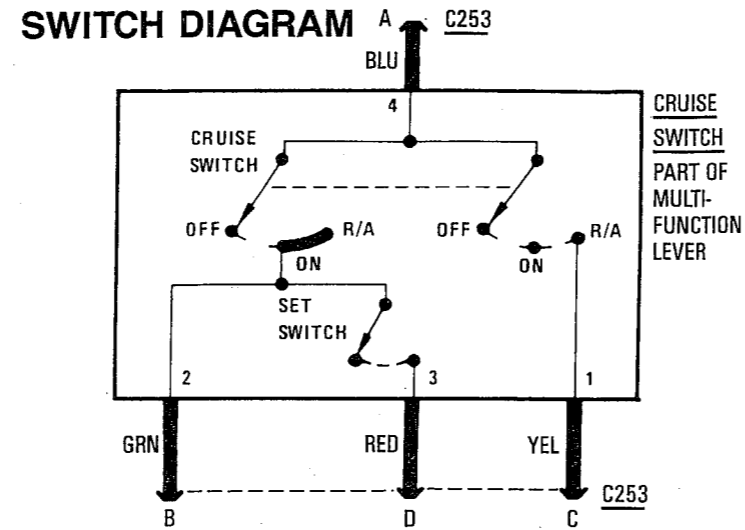
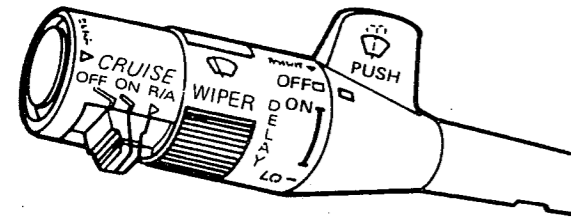

SWITCH TEST

SET/COAST (S/C) SW	POSITION SLIDER	1-2	1-3	1-4	2-3	2-4	3-4
Normal	Off	○	○	○	○	○	○
Normal	On	○	○	○	○	C	○
Normal	R/A	C	○	C	○	C	○
Depressed	Off	○	○	○	C	○	○
Depressed	On	○	○	○	C	C	C
Depressed	R/A	C	C	C	C	C	C

C — Closed (zero ohms)
 ○ — Open (infinite)

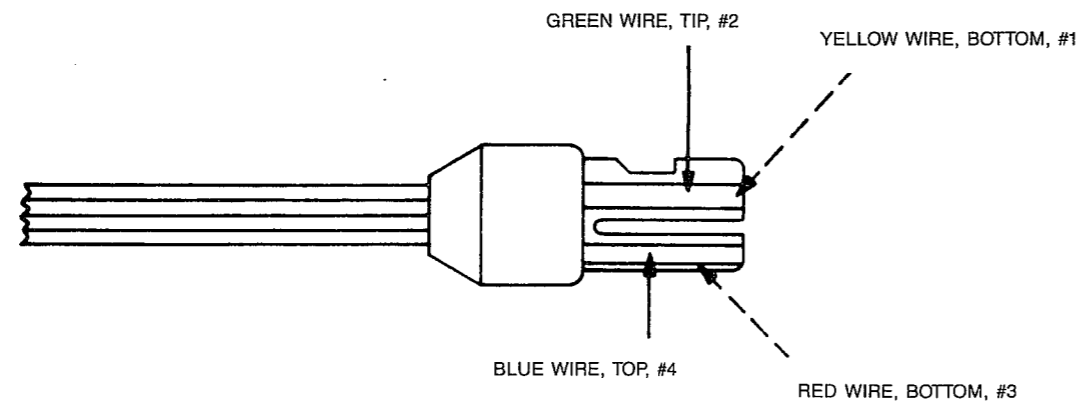

SWITCH TESTING

POWER DOOR LOCKS ONLY / REAR POWER WINDOWS

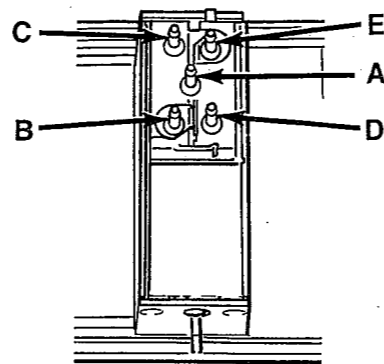
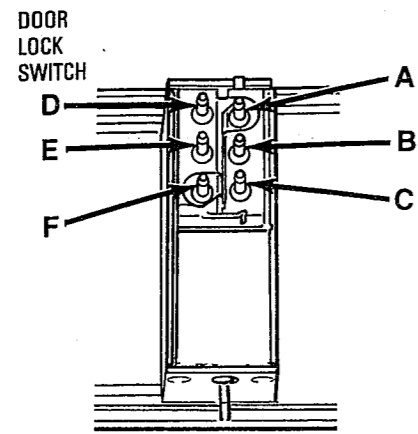

SWITCH DIAGRAM

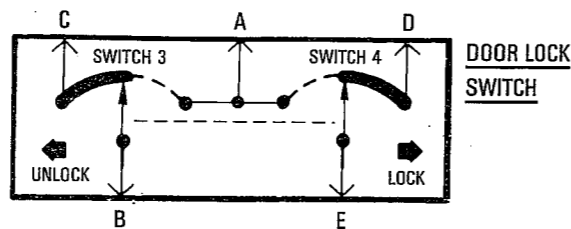

SWITCH TEST LH or RH Switch

SWITCH POSITION	TERMINALS	ZERO OHMS
Off (Normal)	B and C	Yes
	D and E	Yes
	All Others	No
Up (Unlock)	A and E	Yes
	B and C	Yes
	All Others	No
Down (Lock)	A and B	Yes
	D and E	Yes
	All Others	No

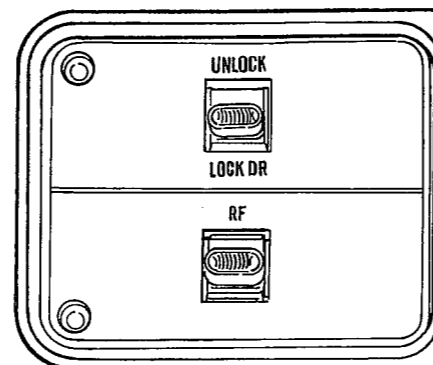
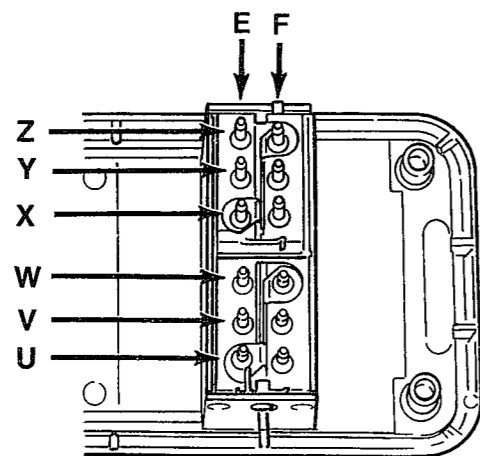

RH DOOR LOCK / WINDOW SWITCH ASSEMBLY

SWITCH DIAGRAM

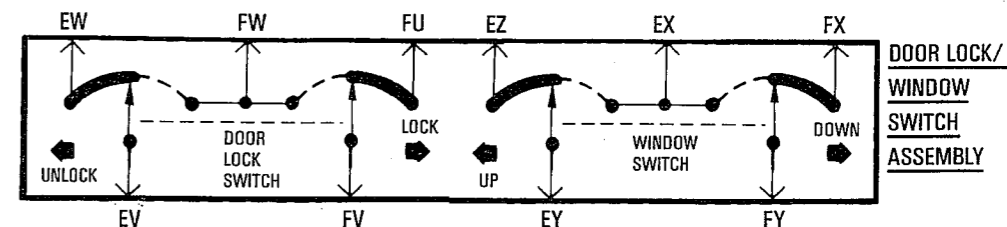

SWITCH TEST Door Lock Switch

SWITCH POSITION	TERMINALS	ZERO OHMS
Off (Normal)	EV and EW	Yes
	FU and FV	Yes
	All Others	No
Up (Unlock)	EV and EW	Yes
	FV and FW	Yes
	All Others	No
Down (Lock)	EV and FW	Yes
	FU and FV	Yes
	All Others	No

SWITCH TEST Window Switch

SWITCH POSITION	TERMINALS	ZERO OHMS
Off (Normal)	EY and EZ	Yes
	FY and FX	Yes
	All Others	No
Up	EY and EZ	Yes
	EX and FY	Yes
	All Others	No
Down	EX and EY	Yes
	FX and FY	Yes
	All Others	No

SWITCH TESTING

MASTER DOOR LOCK / POWER WINDOW SWITCH ASSEMBLY

— 2 DOOR —

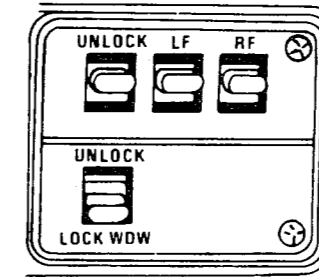
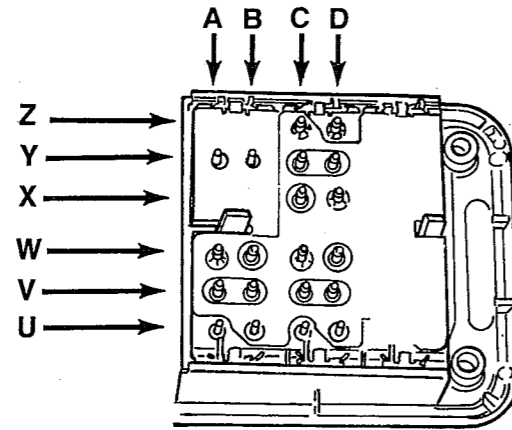

SWITCH DIAGRAM

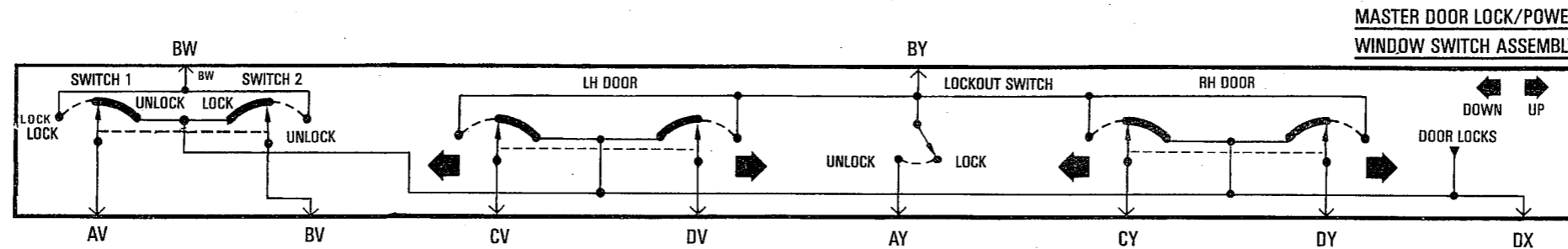

SWITCH TEST
Switch Grounds

SWITCH POSITION	TERMINALS	ZERO OHMS
Off (Normal)	DX and: AV, BV, CV, DV, CY, DY	Yes
	BW and DX	No
	BY and DX	No

SWITCH TEST
RH Door

SWITCH POSITION	TERMINALS	ZERO OHMS
Up	BY and DY	Yes
Down	BY and CY	Yes

SWITCH TEST
Door Lock

SWITCH POSITION	TERMINALS	ZERO OHMS
Up (Unlock)	BV and BW	Yes
Down (Lock)	AV and BW	Yes

SWITCH TEST
Lockout Switch

SWITCH POSITION	TERMINALS	ZERO OHMS
Up (Unlock)	AY and BY	Yes
Down (Lock)	AY and BY	No

SWITCH TEST
LH Door

SWITCH POSITION	TERMINALS	ZERO OHMS
Up	BY and DV	Yes
Down	BY and CV	Yes